

OSI Reference Model TCP/IP

Rev 1.0

www.huawei.com

Objectives

- ➔ **Data Communication Overview**
- ➔ TCP/IP Model
- ➔ Physical Layer
- ➔ DataLink Layer
- ➔ Network Layer
- ➔ Transport Layer
- ➔ Application Layer

Computer Network



SOHO

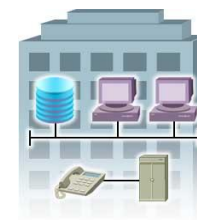

Intranet



Server



Internet



IP Hotel



Wireless

Network Protocols

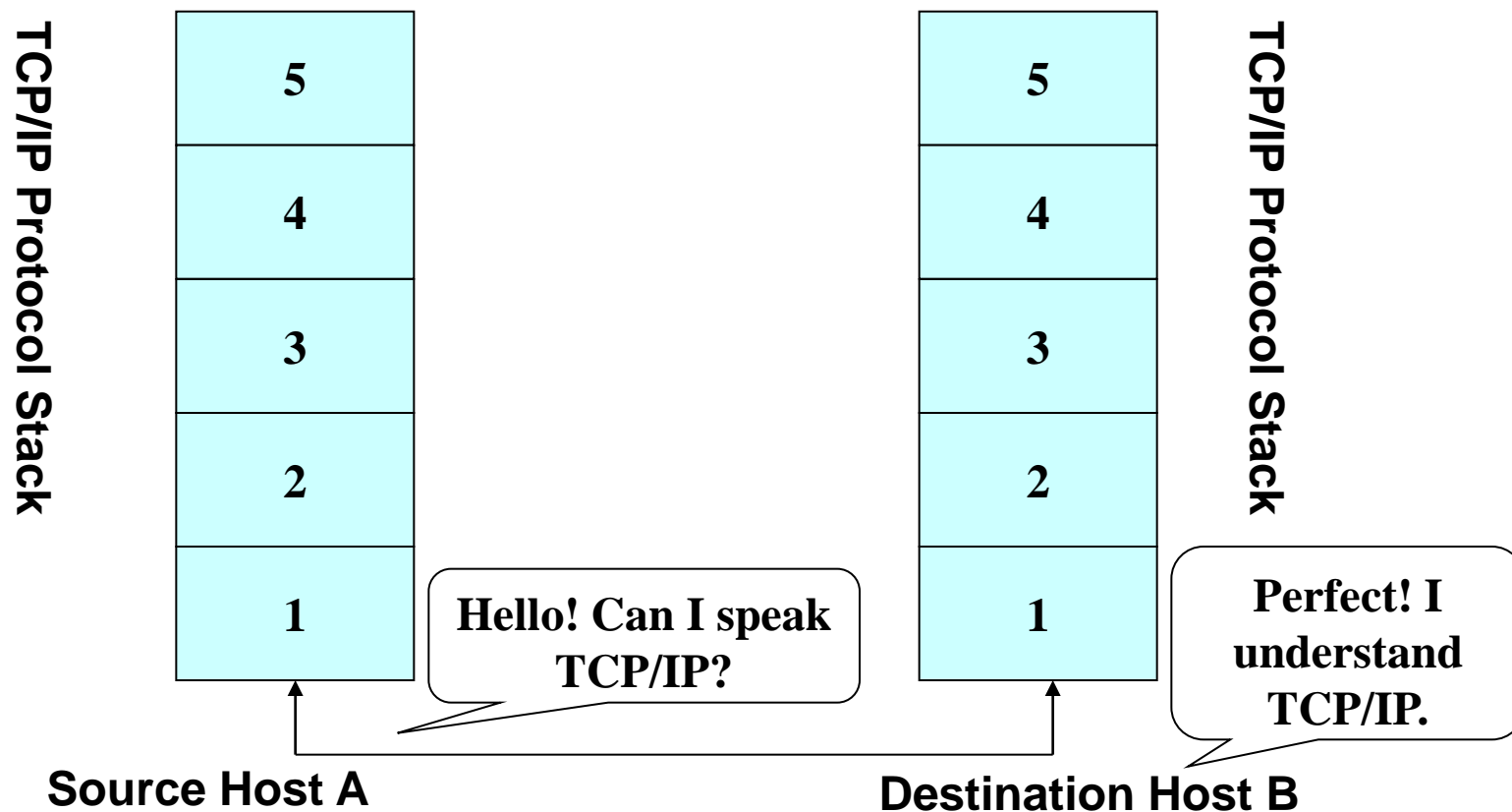

- ➔ Network protocols are formal descriptions of equipment communication rules.

Datacom Equipment

- ➔ **Cable**
- ➔ **Modem**
- ➔ **Router**
- ➔ **Switch**
- ➔ **HUB**
- ➔ **Access Servers**

Transmitting Parameters

- ➔ **Bandwidth:** describes the information volume of the network data transmitted from one node to any other per time unit
- ➔ **Delay:** describe the how much time need for information transmitting from one node to any other

Characteristic of Data Communication

- ➔ **Low requirement for delay**
- ➔ **Accurate transmission**
- ➔ **Connectionless**
- ➔ **Packet switching**

Common Network Topologies

→ Topology:

- Bus, star and tree
- Ring and mesh

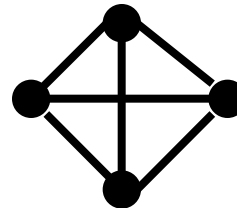
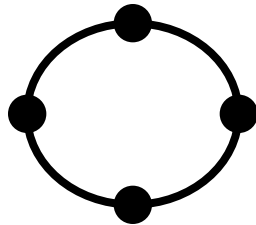
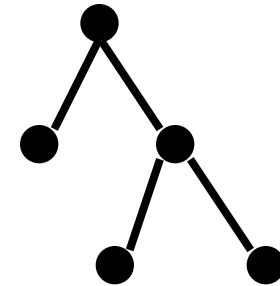
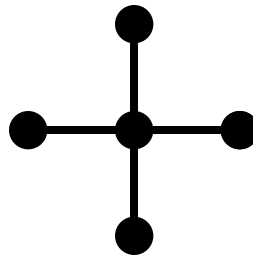
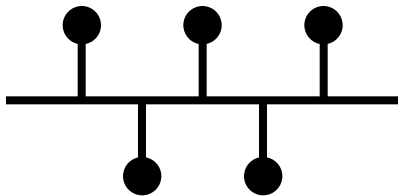

Standardization Organization

➔ International Organization for Standardization (ISO)

- Institute of Electrical & Electronic Engineers (IEEE)
- America National Standard Institute (ANSI)
- Electronic Industries Association/Telecom Industries Association (EIA/TIA)
- International Telecom Union (ITU)
- INTERNET Action Board (IAB)

Objectives

- ➔ Data Communication Overview
- ➔ **TCP/IP Model**
- ➔ Physical Layer
- ➔ DataLink Layer
- ➔ Network Layer
- ➔ Transport Layer
- ➔ Application Layer

What Is TCP/IP

- ➔ TCP/IP has simple hierarchical design
- ➔ In clear corresponding relations with OSI reference model.

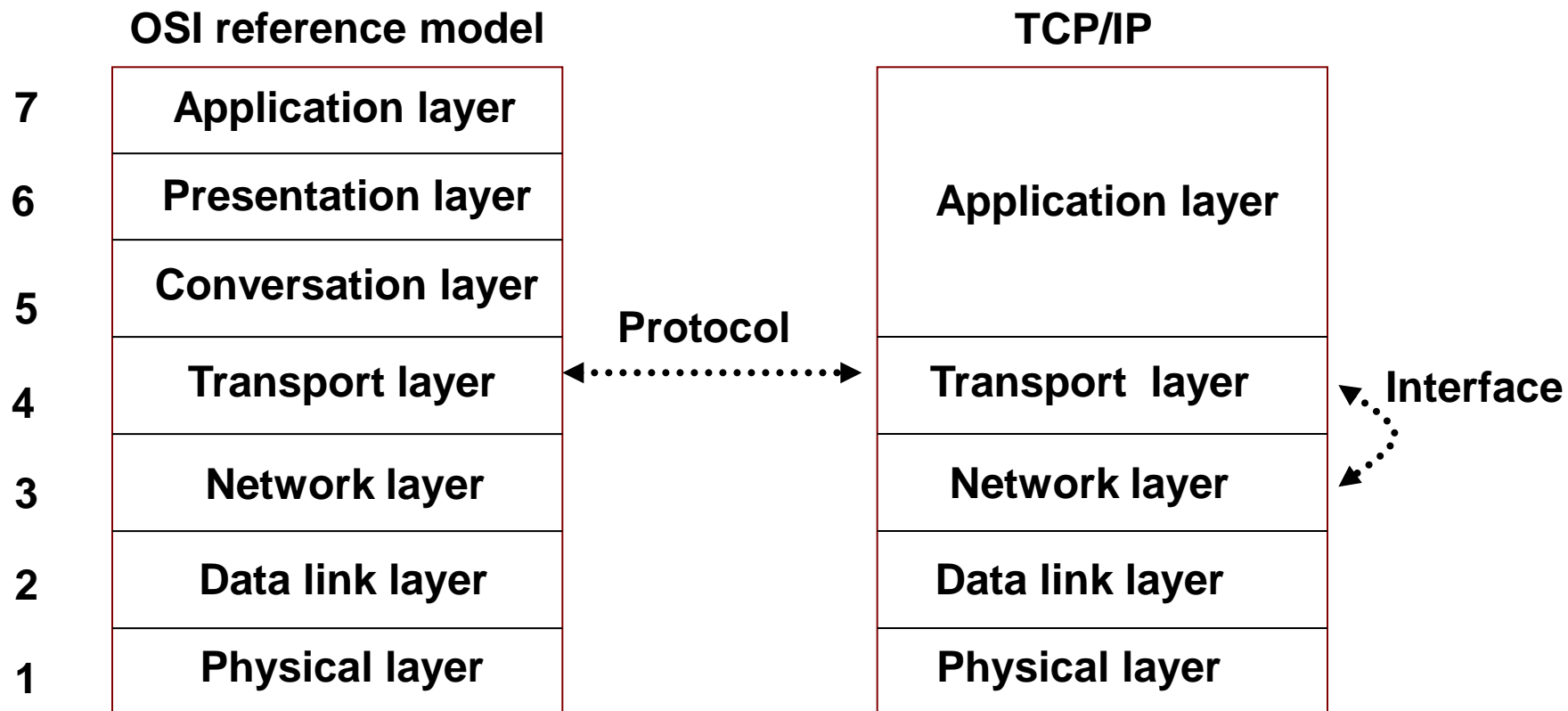

Encapsulation & Decapsulation

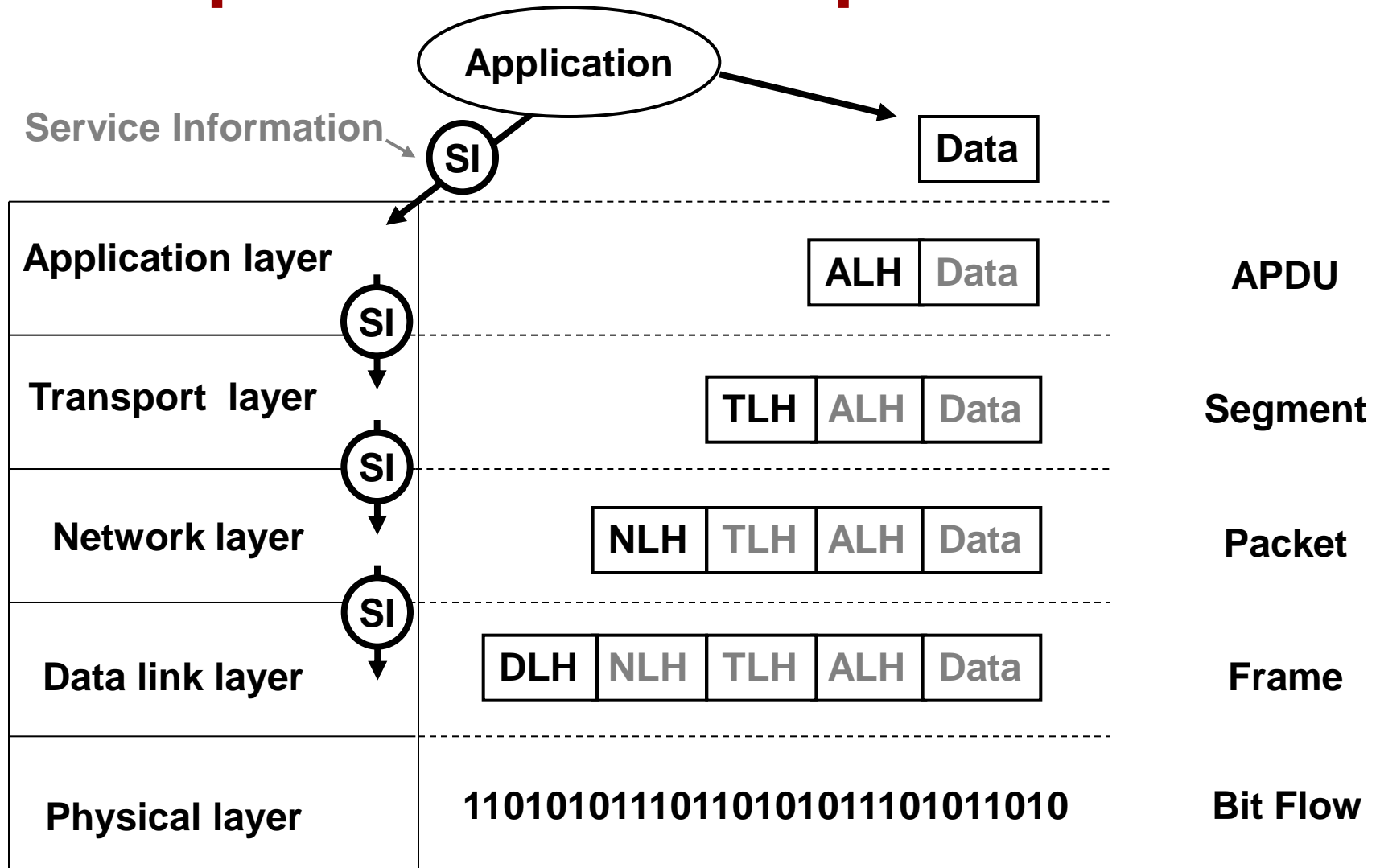

Structure of TCP/IP System

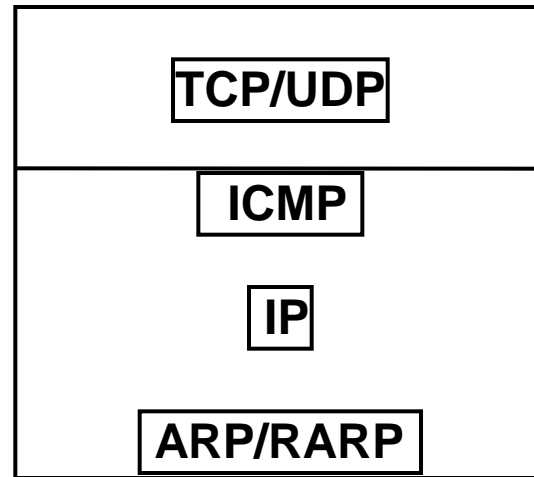

- ➔ **IP is one of the most important protocols in the TCP/IP family. There are 3 other protocols used together with IP:**
- **Address Resolution Protocol (ARP)**
 - **Reverse Address Resolution Protocol (RARP)**
 - **Internet Control Message Protocol (ICMP)**

Structure of TCP/IP System

- ➔ IP provides a globally unified addressing mode, shields the differences of the physical network addresses and makes routing possible.
- ➔ IP provides a globally unified message format, shields the differences of the network link layers and makes network interconnection possible.

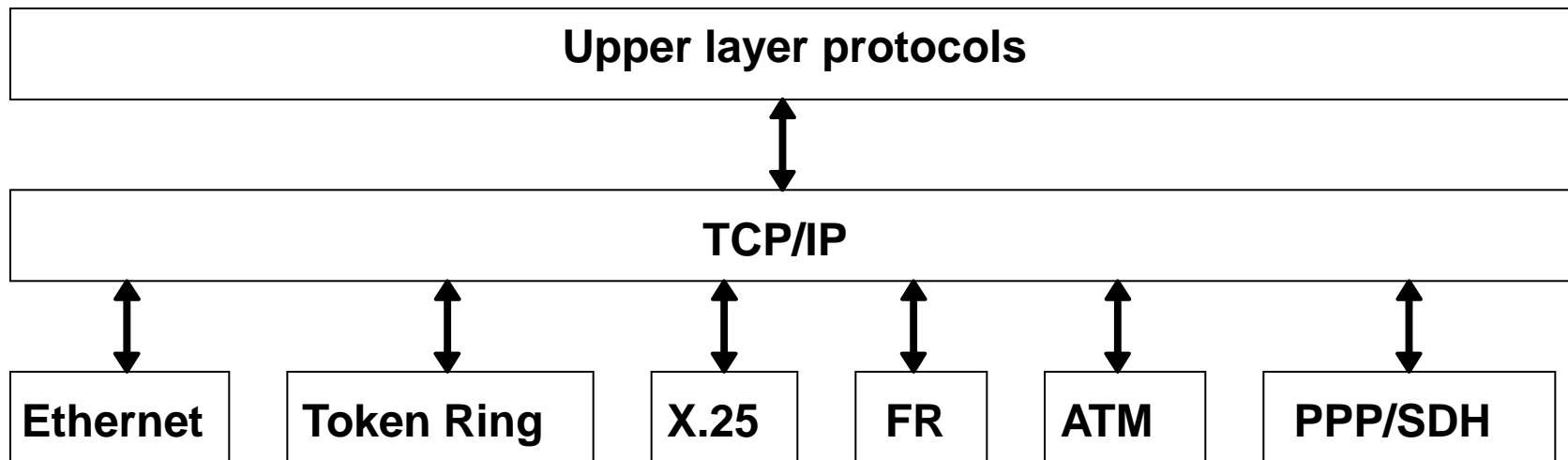

Data Encapsulation

TELNET 23	FTP 20/21	SMTP 25	TFTP 69
TCP/UDP (Port) 6/17			
IP PACKETS (Protocol) 0x0800			
FRAMES (Type, VPI/VCI, DLCI, ...)			
BITS			

TCP/IP Protocol Stack

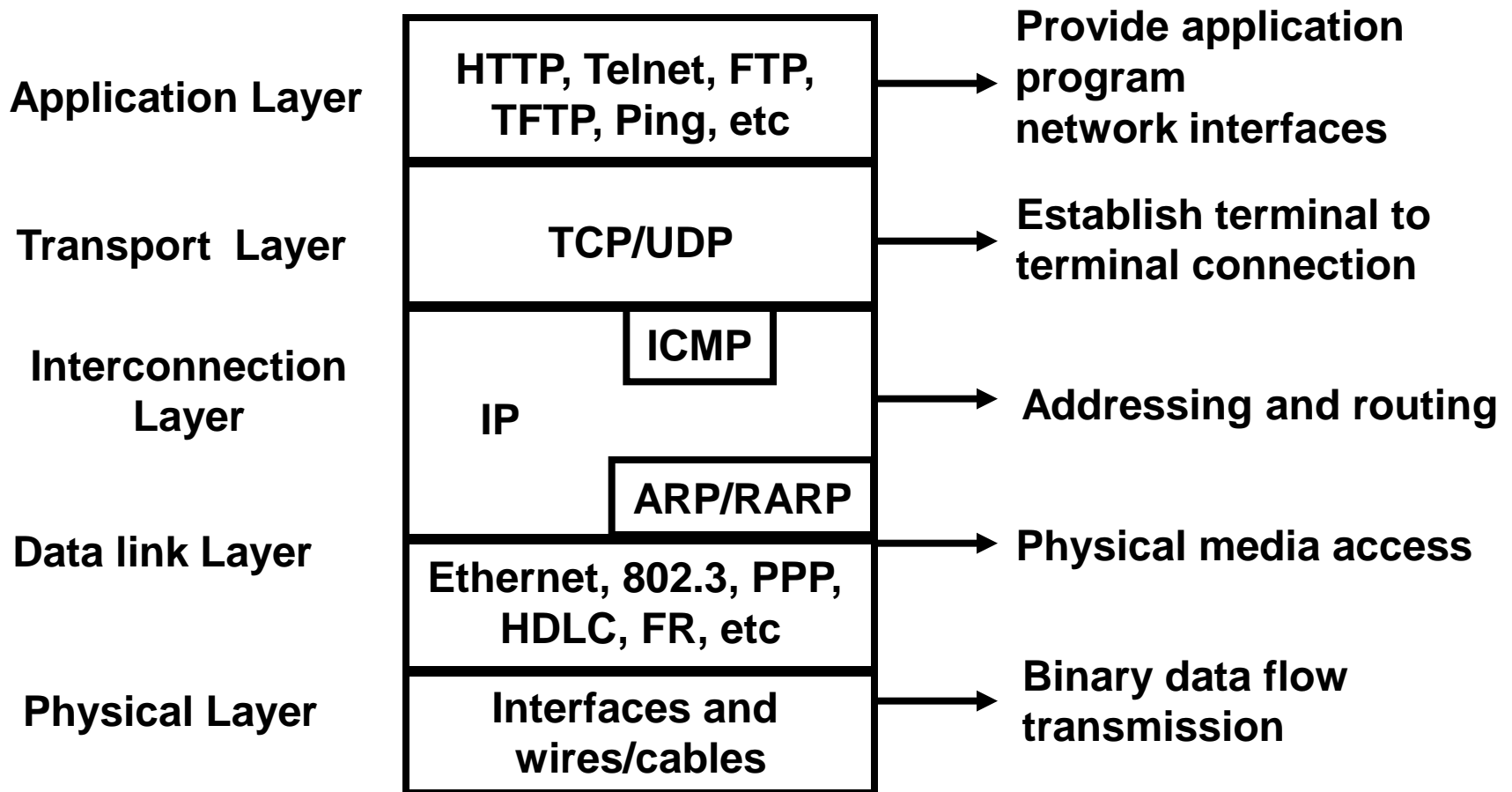

TCP/IP Conceptual Layers

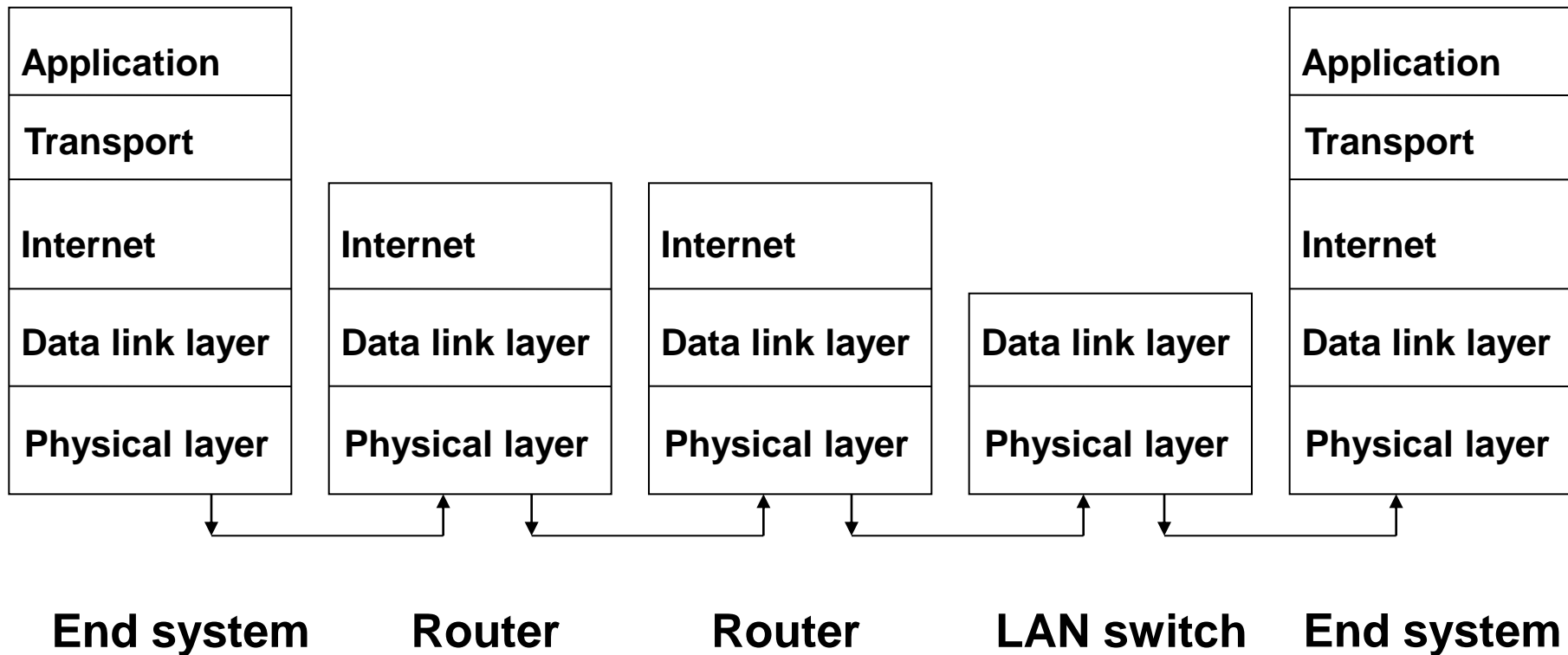

Peer Layer

- ➔ If two networks are identical in physical layers, they can be interconnected with repeaters.
- ➔ If two networks are different in physical layers but identical in link layers, they can be interconnected with bridges.
- ➔ If two networks are different in both physical layers and link layers, but they are identical in network layers, then they can be interconnected with routers.
- ➔ If two networks have identical protocols, they can be interconnected with protocol converters (gateway).

Objectives

- ➔ Data Communication Overview
- ➔ TCP/IP Model
- ➔ **Physical Layer**
- ➔ DataLink Layer
- ➔ Network Layer
- ➔ Transport Layer
- ➔ Application Layer

Physical Layer

- ➔ **Physical layer: defines the voltage, interface, cable standard and transmission distance etc.**
- ➔ **Physical layer cable:**
 - **Twisted pair : UTP , STP**
 - **Coaxial cable: thin, thick**
 - **Fiber**
 - **Wireless radio: WLAN**

Physical Layer

➔ LAN and Physical Layer

- Cable standard: 10Base-T, 100Base-T and 1000Base-SX etc.;
- Network equipment: repeater and hub etc.

➔ WAN and Physical Layer

- DTE equipment: router and terminal host etc.;
- DCE equipment: WAN switch and Modem etc.;
- Common interface: RS-232, V.24 and V.35 etc.

Objectives

- ➔ Data Communication Overview
- ➔ TCP/IP Model
- ➔ Physical Layer
- ➔ **DataLink Layer**
- ➔ Network Layer
- ➔ Transport Layer
- ➔ Application Layer

Data Link Layer Overview

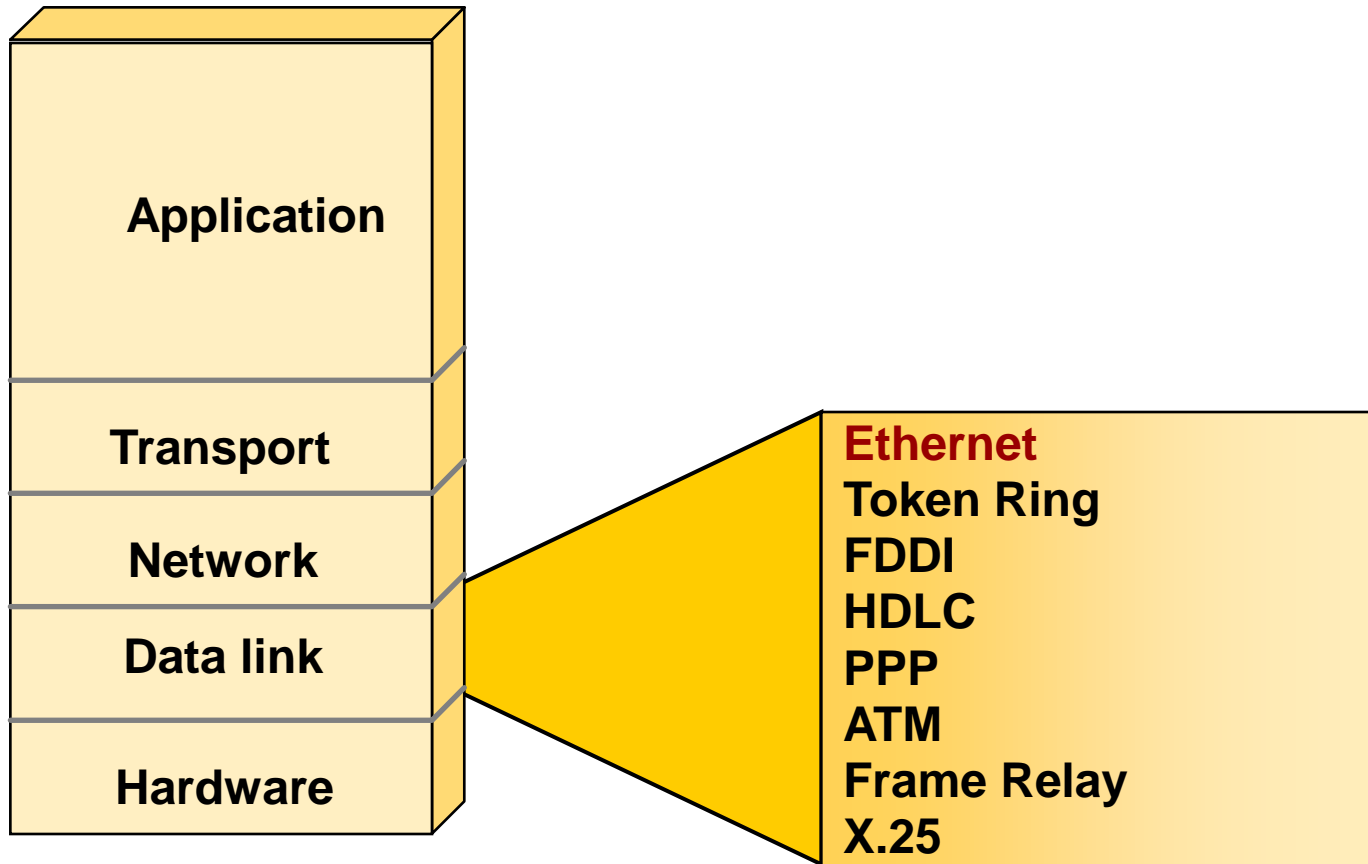

Data Link Layer

➔ **Data Link Layer divided into two sublayer:**

- **The LLC sublayer**
- **The MAC sublayer**

➔ **The Function of Data Link Layer:**

- **Physical address definition**
- **Network topology**
- **Link parameter**
- **Error verification**
- **Physical media access**
- **Flow control (optional)**

LAN and Data Link Layer

➔ **IEEE802 Standard: the most popular LAN standard nowadays**

- **IEEE802.1 Common LAN Conceptions**
- **IEEE802.2 Definition of LLC Sub-Layer**
- **IEEE802.3 Ethernet Standard**
- **IEEE802.4 Token Bus Network**
- **IEEE802.5 Token Ring Network**

➔ **Ethernet switch**

WAN and Data Link Layer

➔ WAN data link layer standard:

- HDLC
- PPP
- ISDN
- Frame Relay

➔ WAN data link layer equipment

- Modem and ISDN terminal adaptor
- CSU/DSU and WAN switch

MAC Address

➔ Unicast

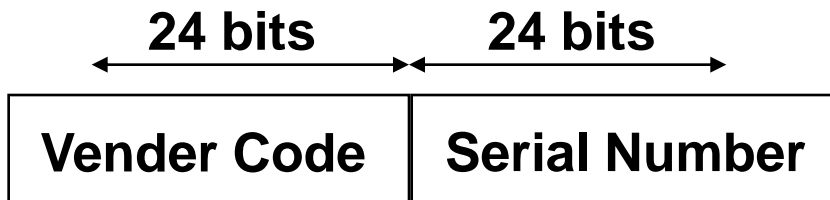

00E0FC 012345

➔ Broadcast (All bits equal “1”: 0xFFFFFFFFFFFFFF)

➔ Multicast (8th bit equal “1”):

00000001	10111011	00111010	10111010	10111110	10101000
----------	----------	----------	----------	----------	----------

Objectives

- ➔ Data Communication Overview
- ➔ TCP/IP Model
- ➔ Physical Layer
- ➔ DataLink Layer
- ➔ **Network Layer**
- ➔ Transport Layer
- ➔ Application Layer

Network Layer Overview

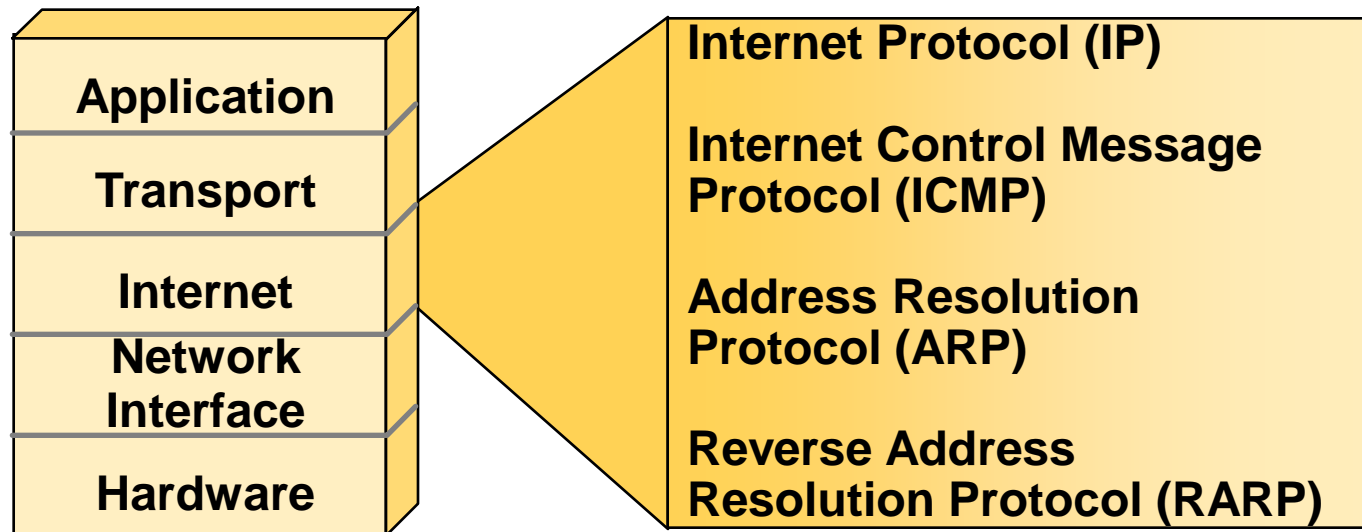

Flat Network

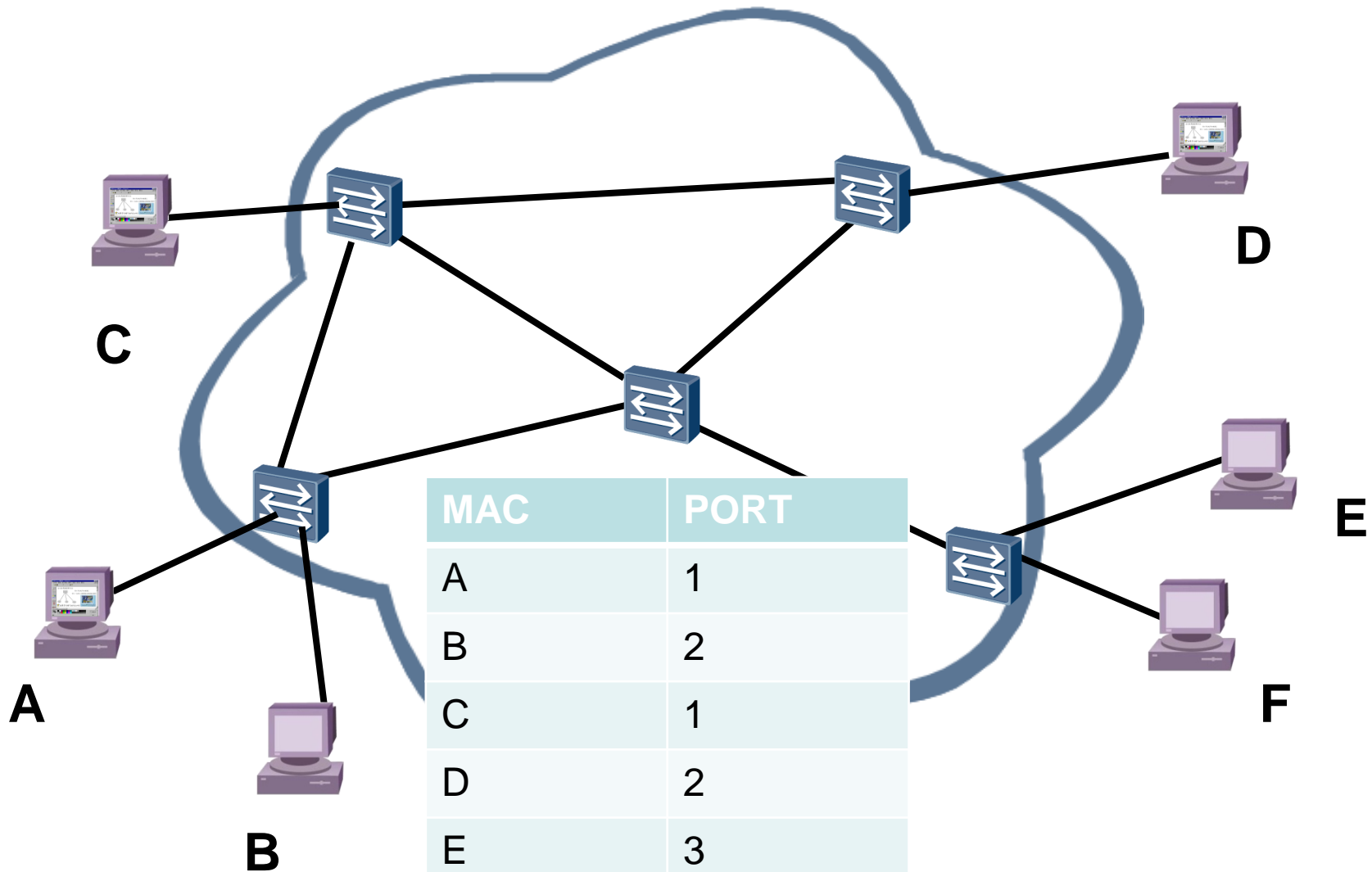

MAC	PORT
A	1
B	2
C	1
D	2
E	3
F	2
G	1

IP Forwarding (Routing)

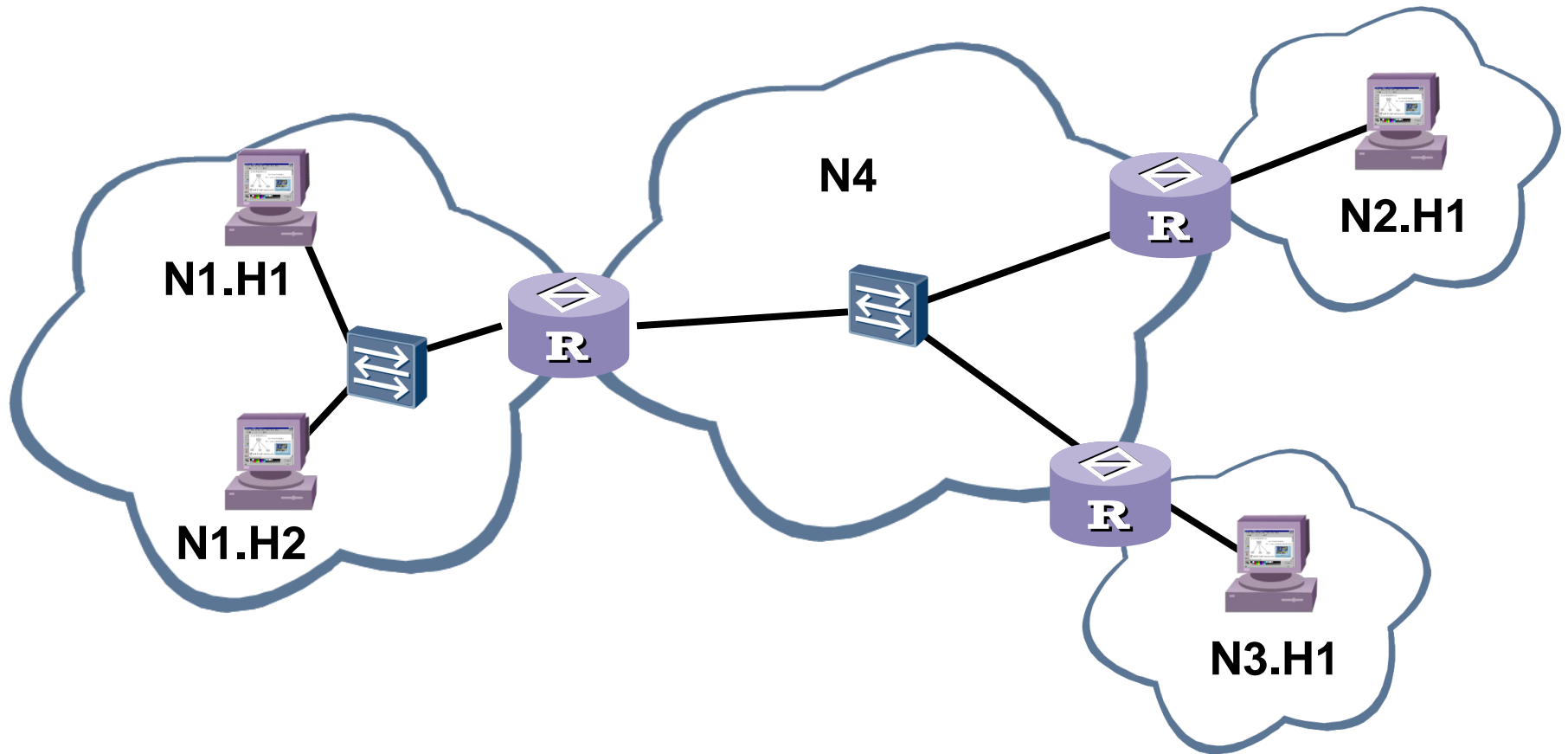

IP Addressing

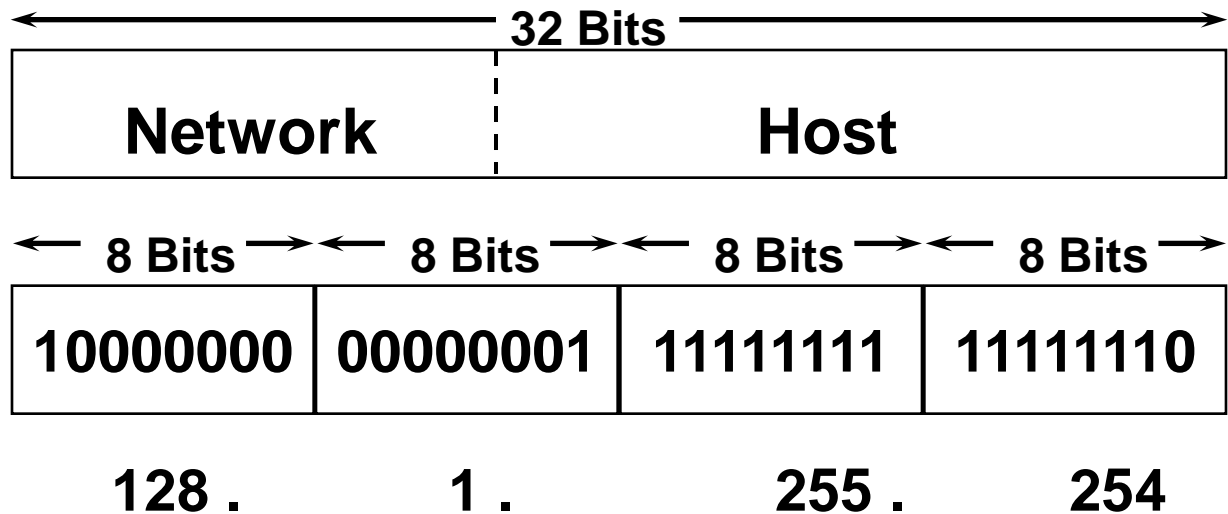

IP Forwarding Process

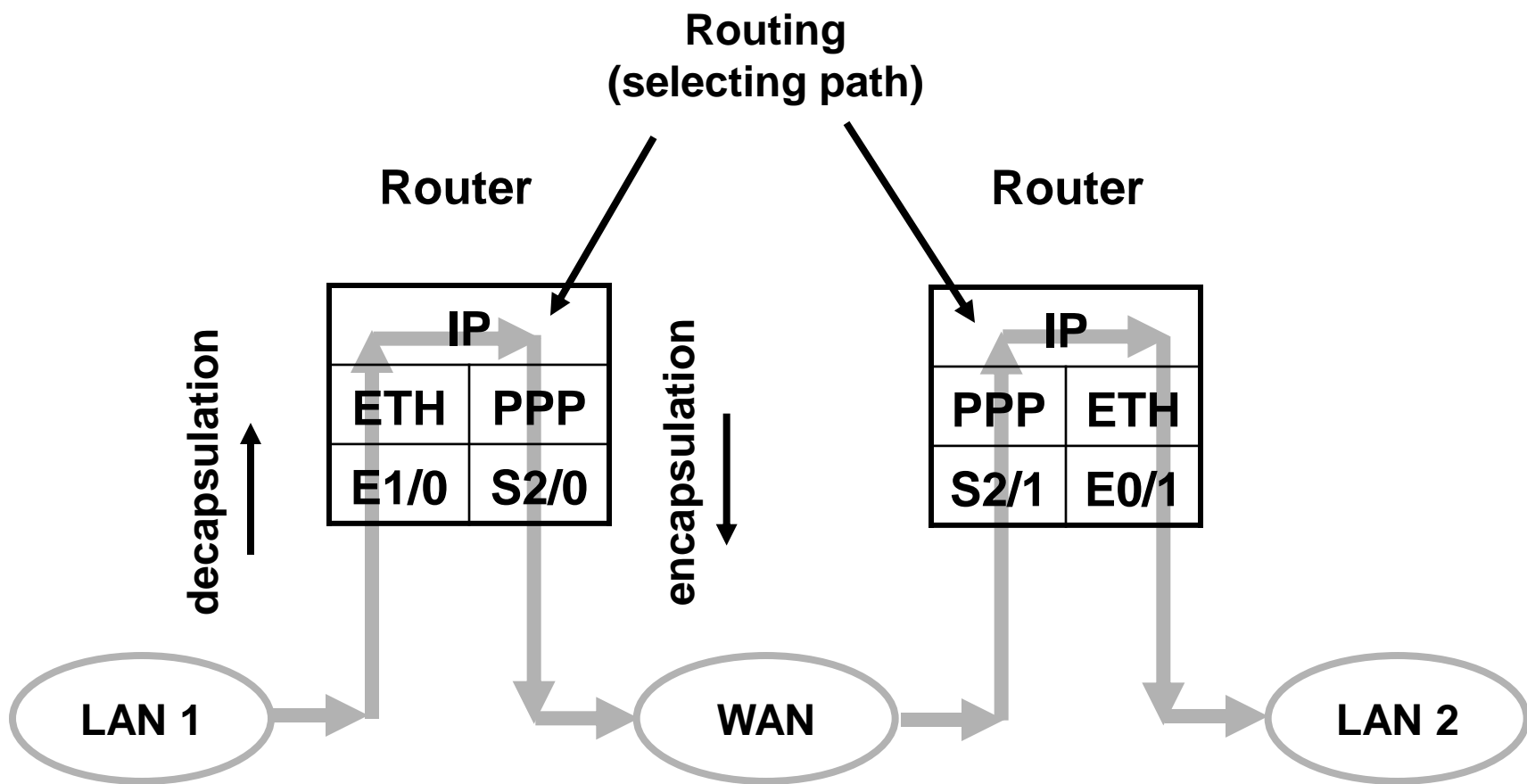

Address Resolution Protocol

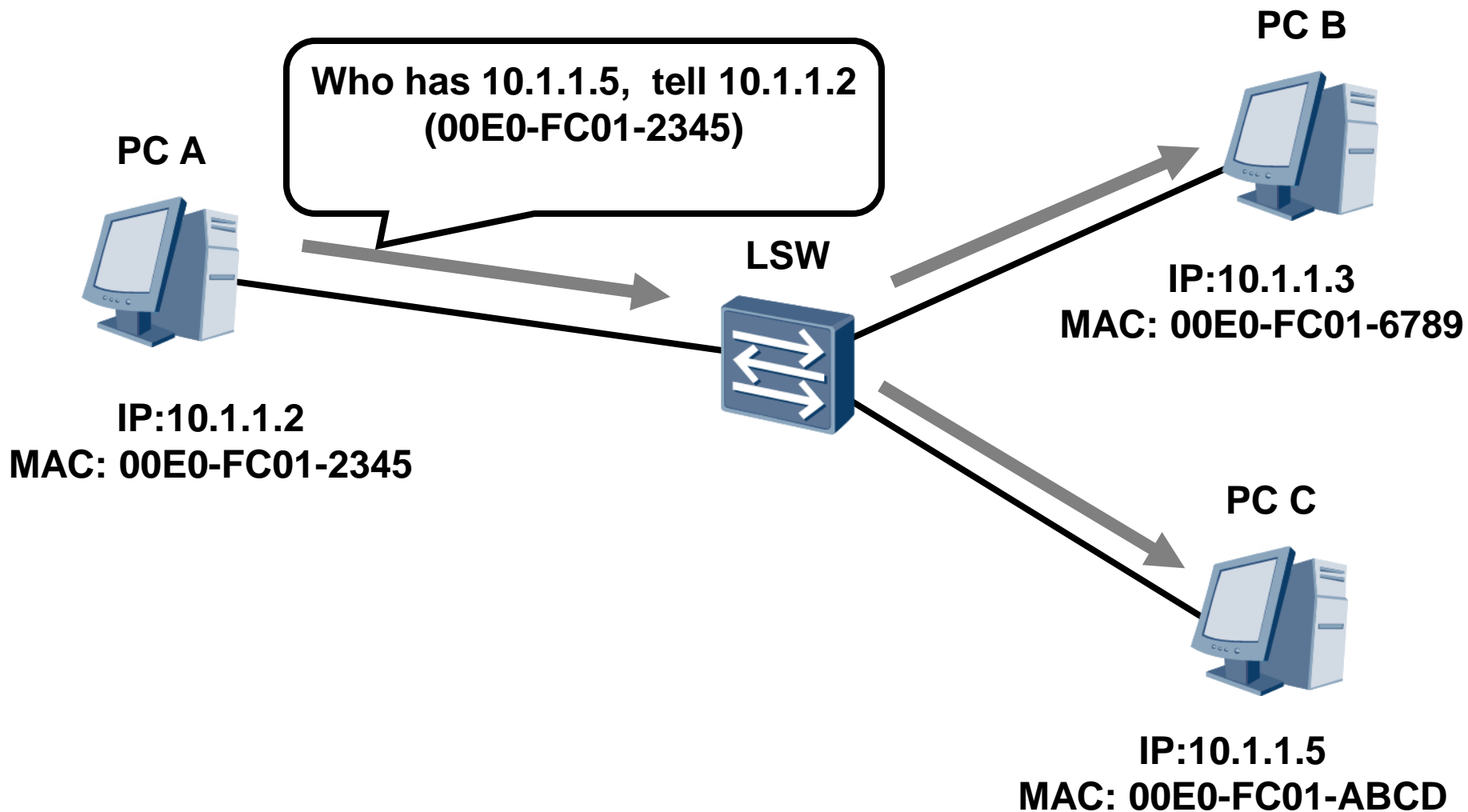

Address Resolution Protocol

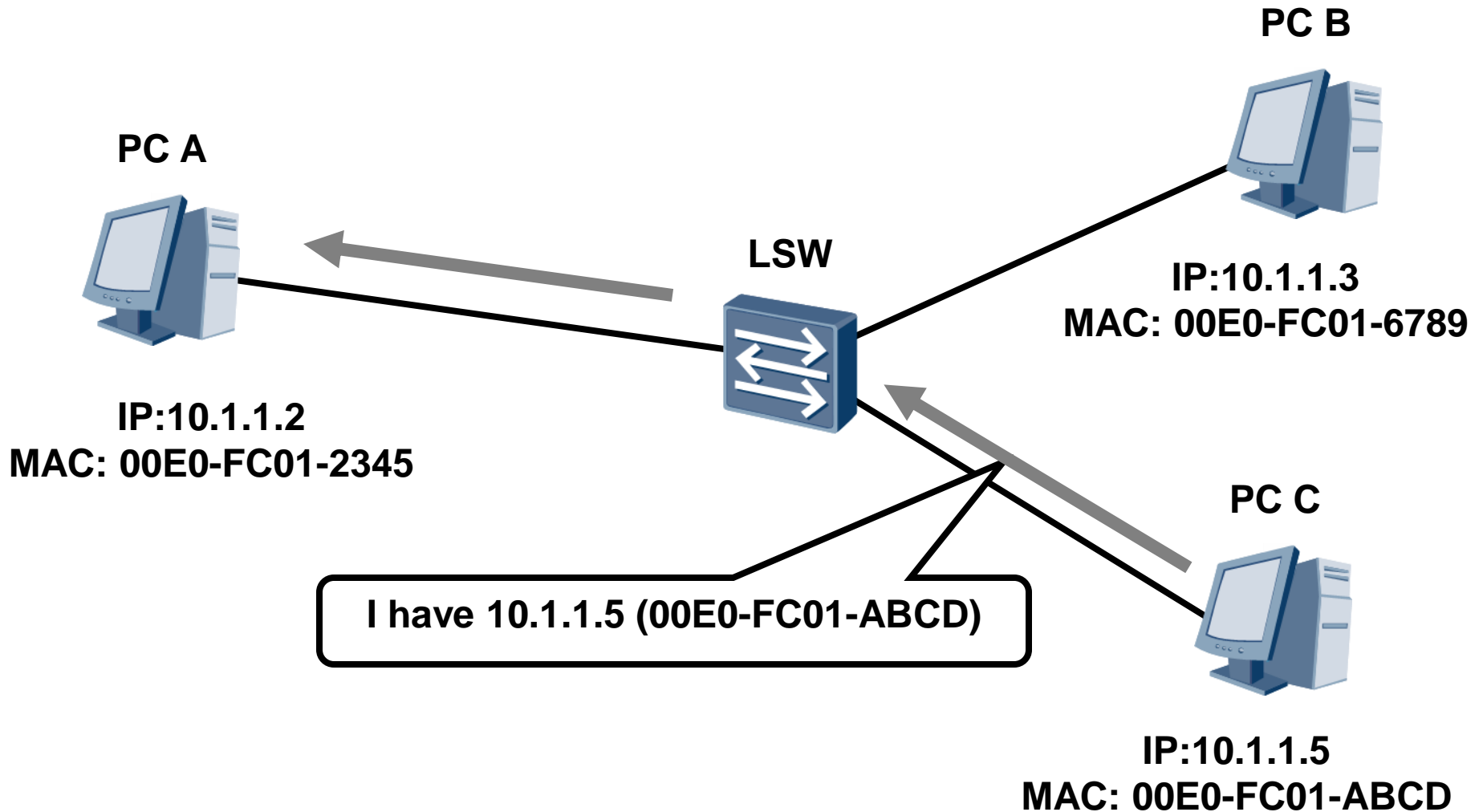

ICMP

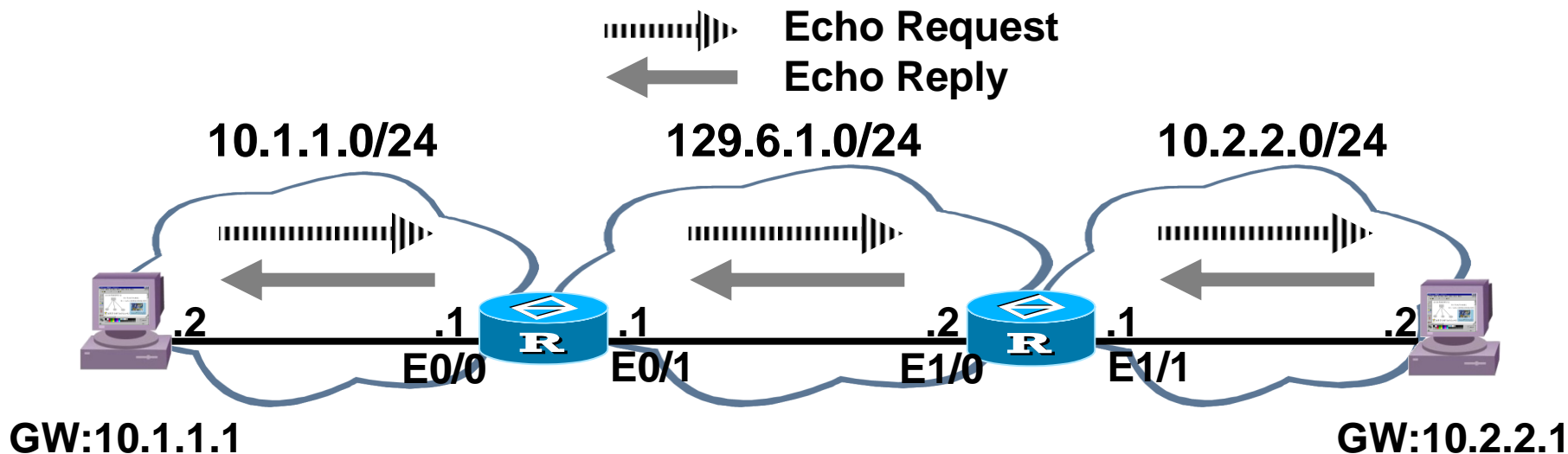

ping 10.2.2.1

Reply from 10.2.2.1: bytes=32 time<1ms TTL=252

Dest./Mask	NextHop	Interface
10.1.1.0/24	10.1.1.1	E0/0
10.2.2.0/24	129.6.1.2	E0/1
129.6.1.0/24	129.6.1.1	E0/1

Dest./Mask	NextHop	Interface
10.1.1.0/24	129.6.1.1	E1/0
10.2.2.0/24	10.2.2.1	E1/1
129.6.1.0/24	129.6.1.2	E1/0

ICMP

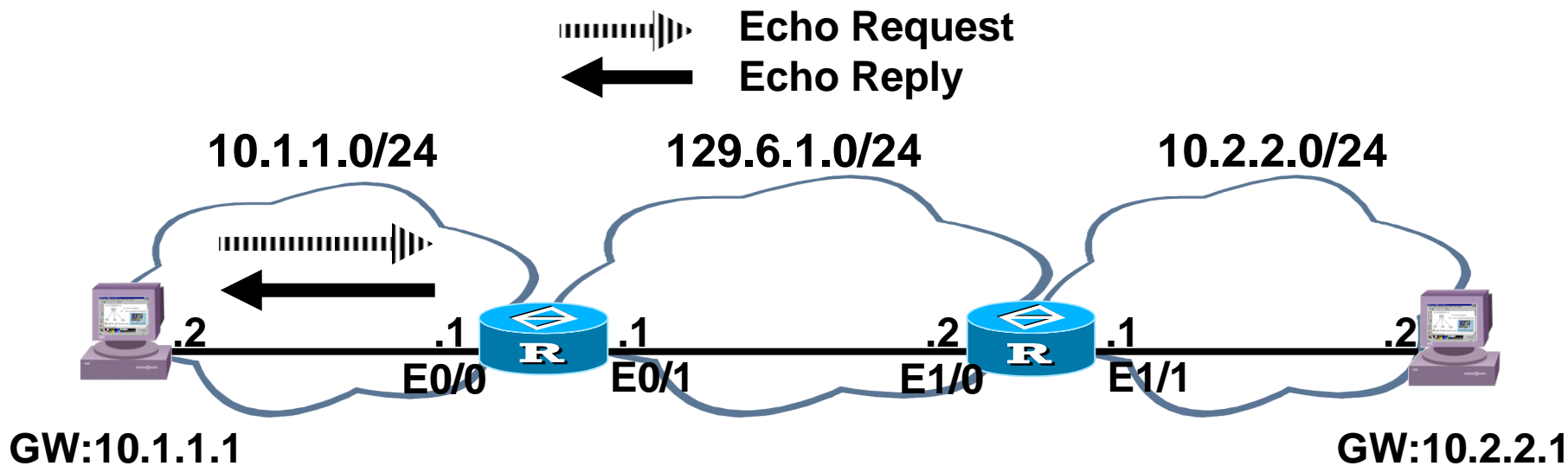

ping 10.2.2.1

Reply from 10.1.1.1: Destination host unreachable

Dest./Mask	NextHop	Interface
10.1.1.0/24	10.1.1.1	E0/0
129.6.1.0/24	129.6.1.1	E0/1

Dest./Mask	NextHop	Interface
10.1.1.0/24	129.6.1.1	E1/0
10.2.2.0/24	10.2.2.1	E1/1
129.6.1.0/24	129.6.1.2	E1/0

Objectives

- ➔ Data Communication Overview
- ➔ TCP/IP Model
- ➔ Physical Layer
- ➔ DataLink Layer
- ➔ Network Layer
- ➔ **Transport Layer**
- ➔ Application Layer

Transport Layer Overview

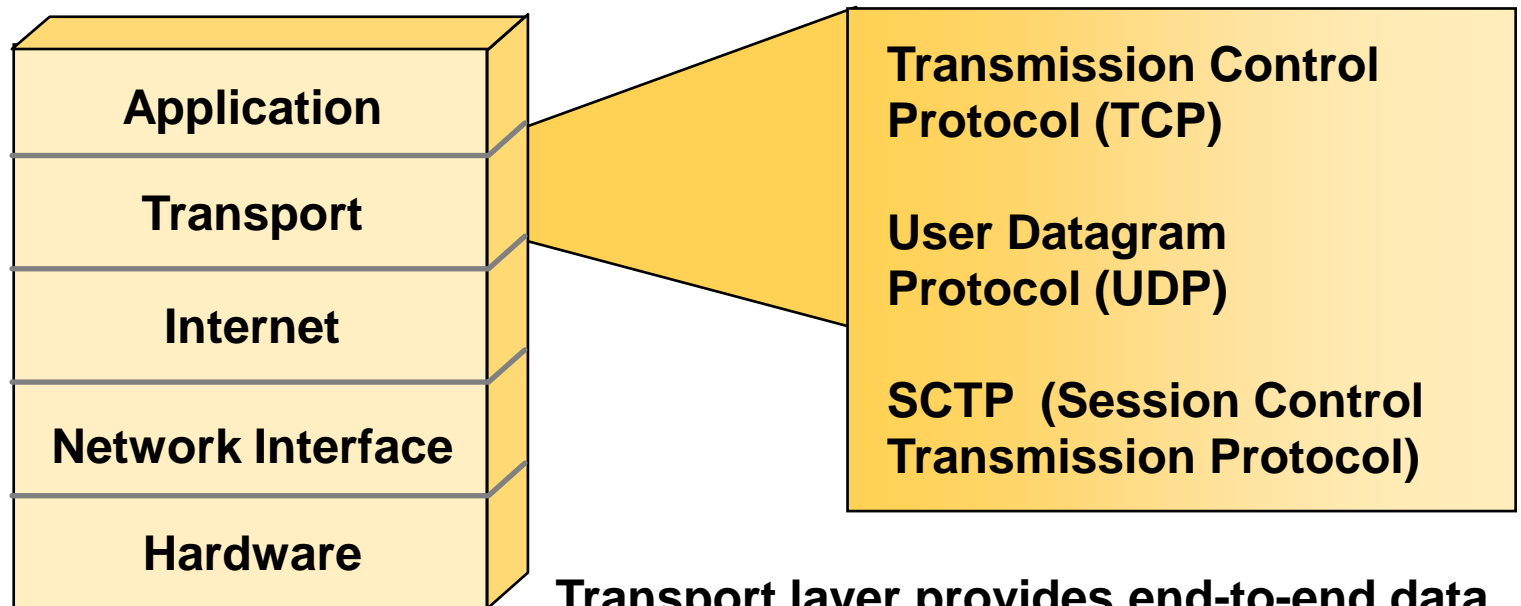

Transport layer provides end-to-end data transfer.

TCP provides a reliable exchange of information and UDP is not.

TCP and UDP

TCP:

- **connection-oriented**
- **reliable transmission.**
- **The relevant application layer protocols include TELNET, FTP and HTTP.**

UDP:

- **connectionless**
- **unreliable transmission.**
- **The relevant application layer protocols include RIP, SNMP, RADIUS and VOD.**

TCP/UDP Header Format

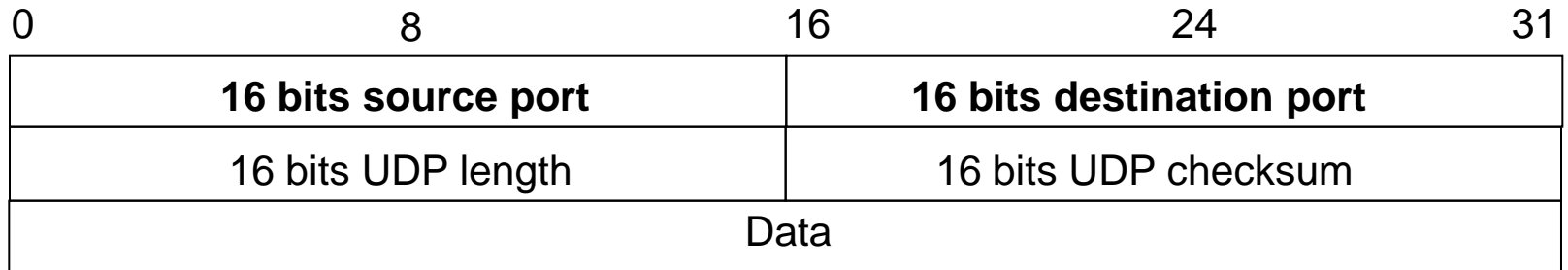

UDP header format

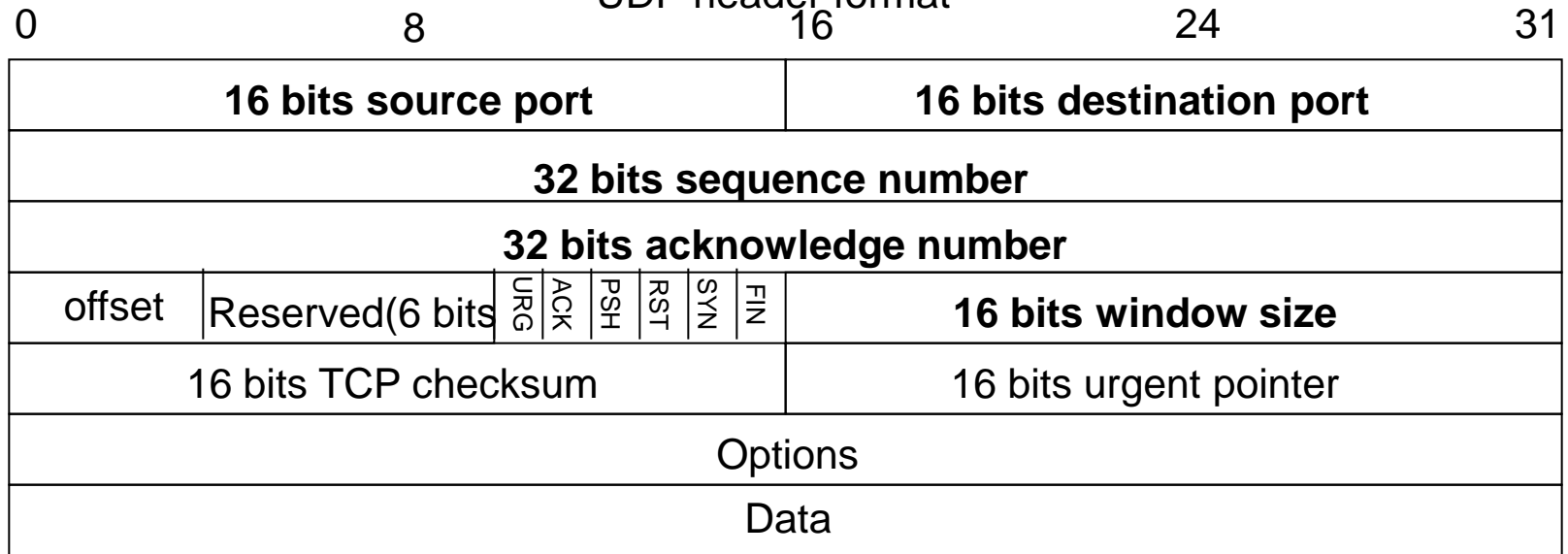

TCP header format

End to End Communication

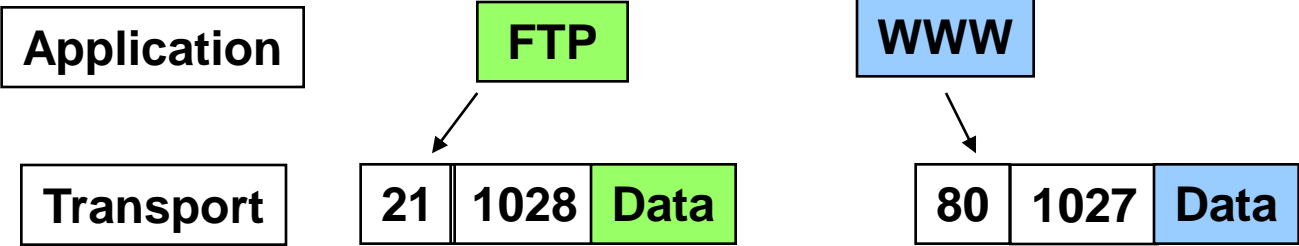
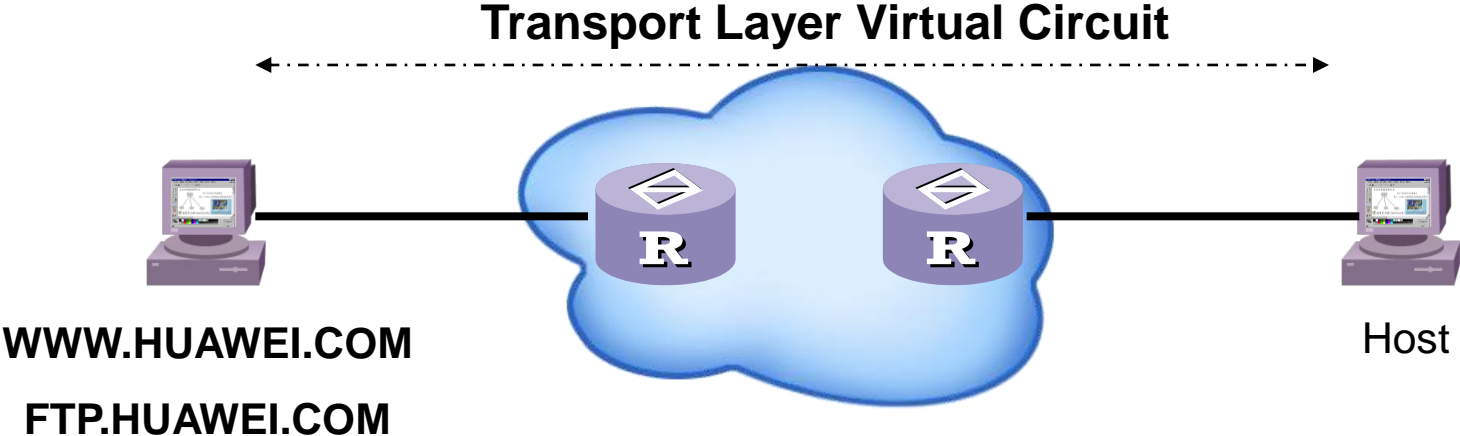

TCP Connection

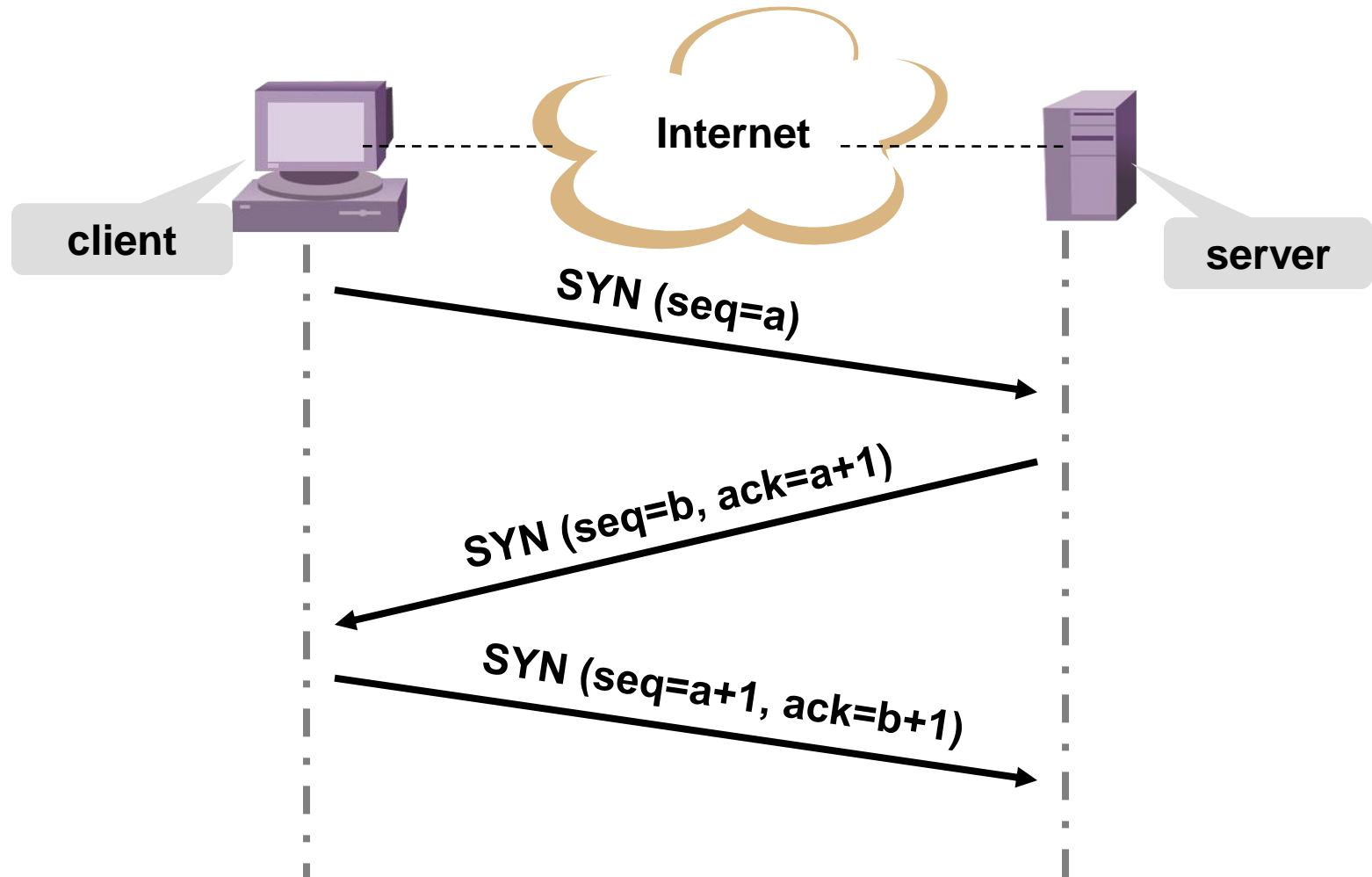

Acknowledgement Technology

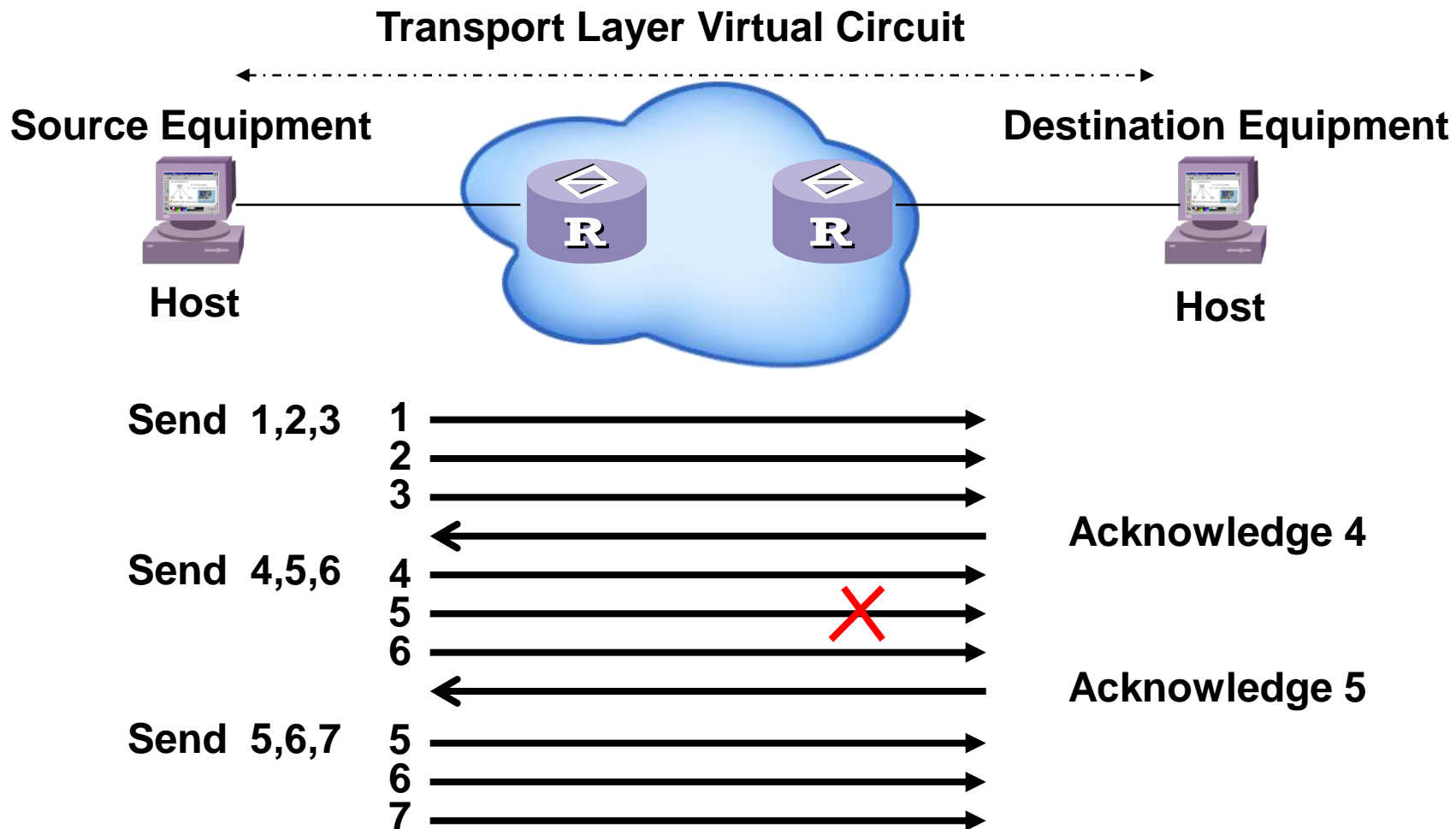

Flow Control

➔ Three method of flow control:

- **Buffering:** burst data buffered, forward when idle.
- **Source quench message:** send the source quench message by ICMP
- **windowing:** use to control how many data be sent at one time

Slide Window

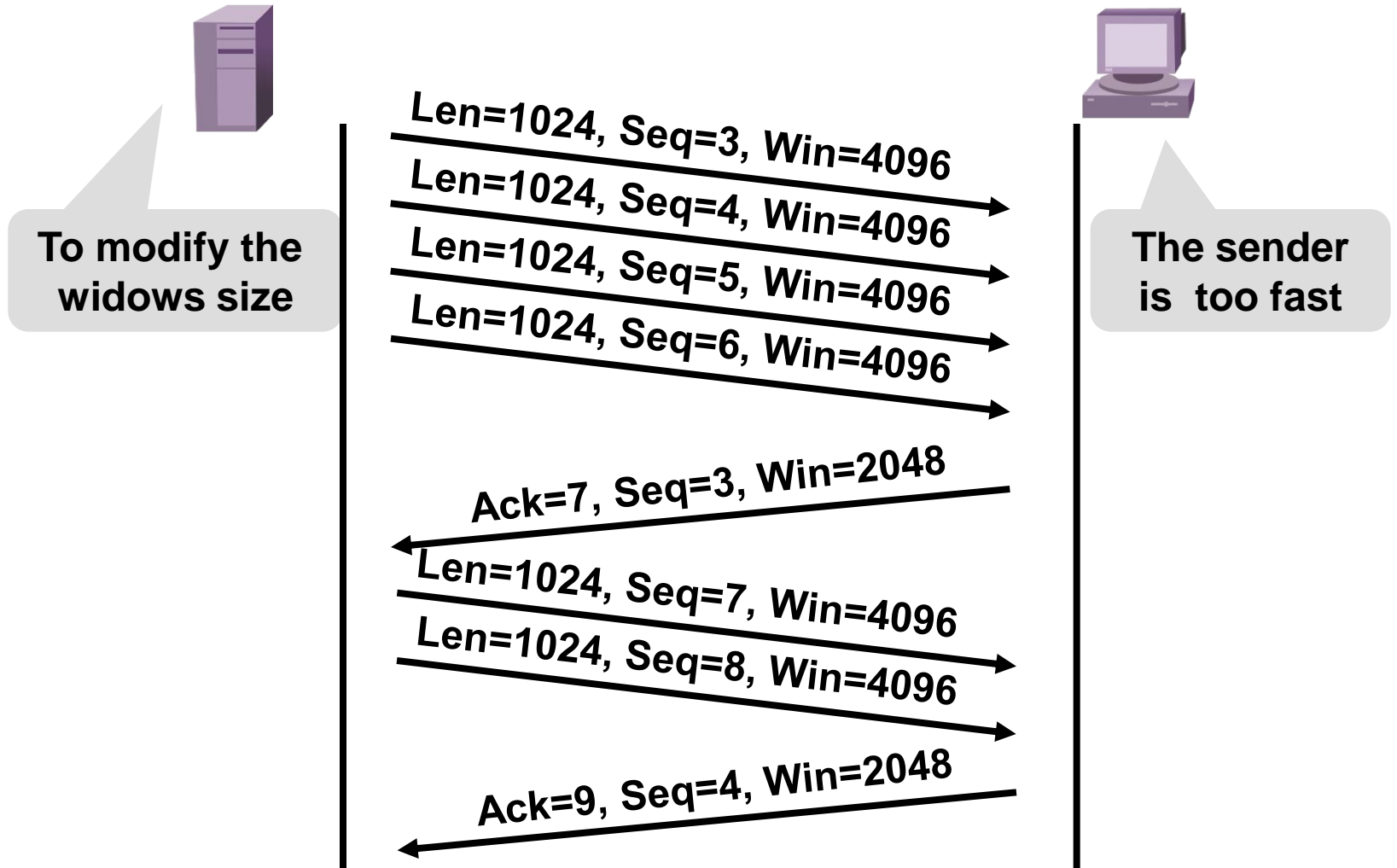

Why SCTP – TCP defects

- **TCP**---- connection-oriented and transmission-reliable
- **UDP**---- connectionless, packet-based, and without transmission-reliable
- **SCTP**-- connection-oriented, packet-based, and transmission-reliable

→ TCP Defects

- **Line header block**
- **Poor real-time ability**
- **Difficult multi-homing implementation**
- **Vulnerable to denial of service (DOS) attacks**



Comparison of UDP, TCP and SCTP

- ➔ **Connection-oriented, packet-based, optimized real-time performance**
- ➔ **Use streams to solve line header block**
- ➔ **Adopt 4-step startup to avoid DOS attack**
- ➔ **Supports the multi-homing function**
- ➔ **appropriate congestion avoidance behavior and resistance to flooding and masquerade attacks**

SCTP Terminology

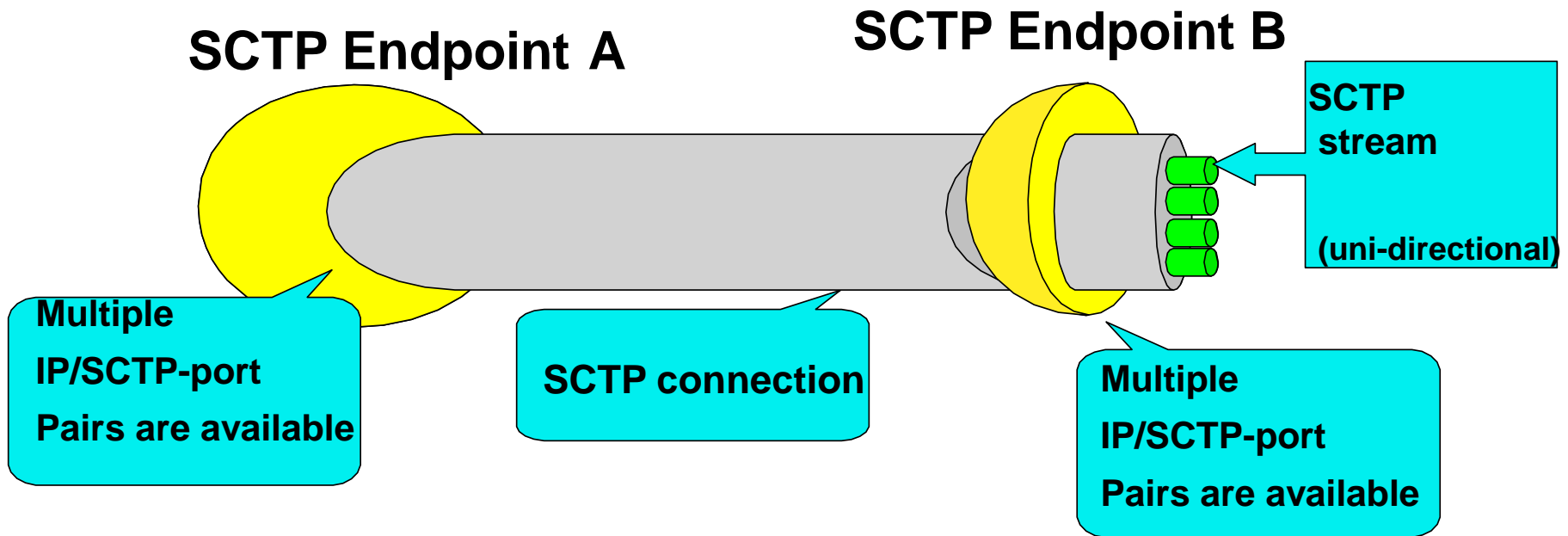

SCTP Functions

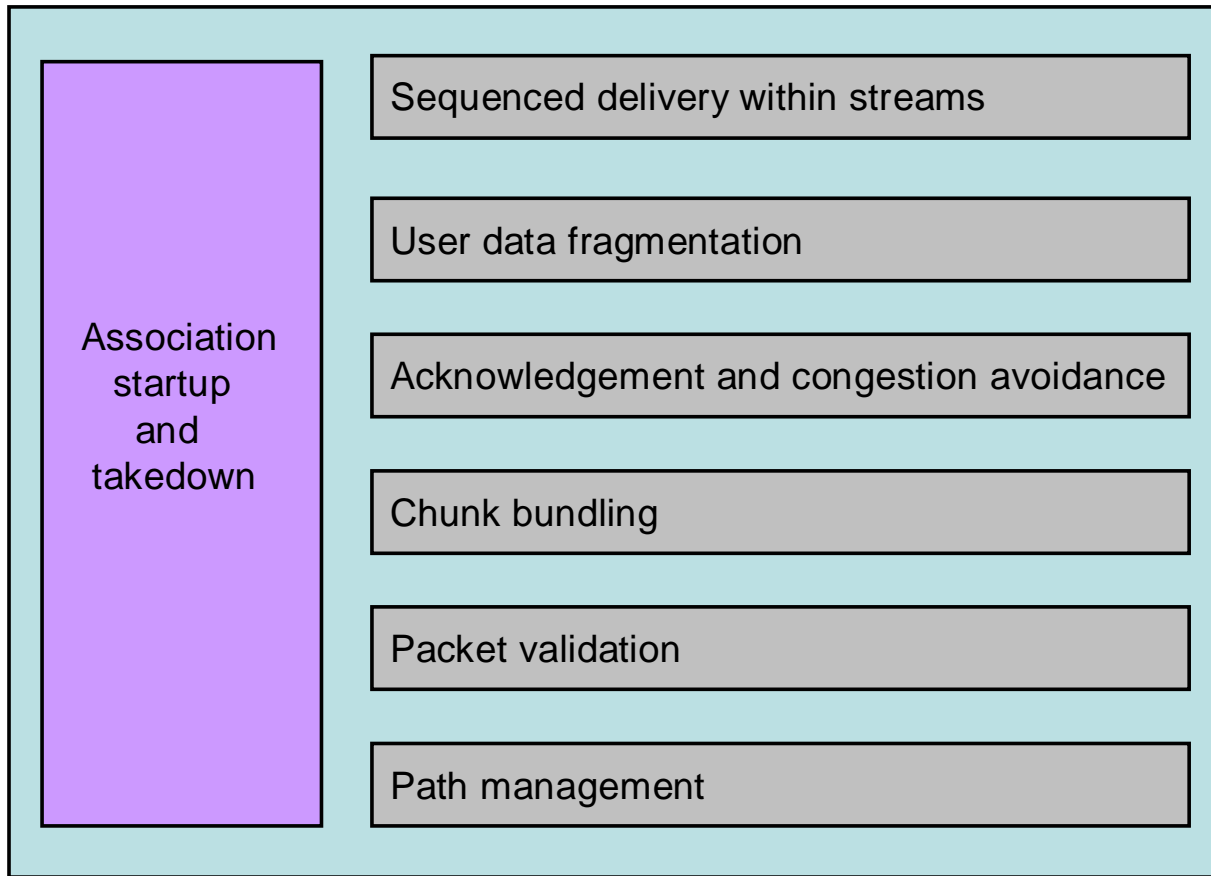

Association Startup

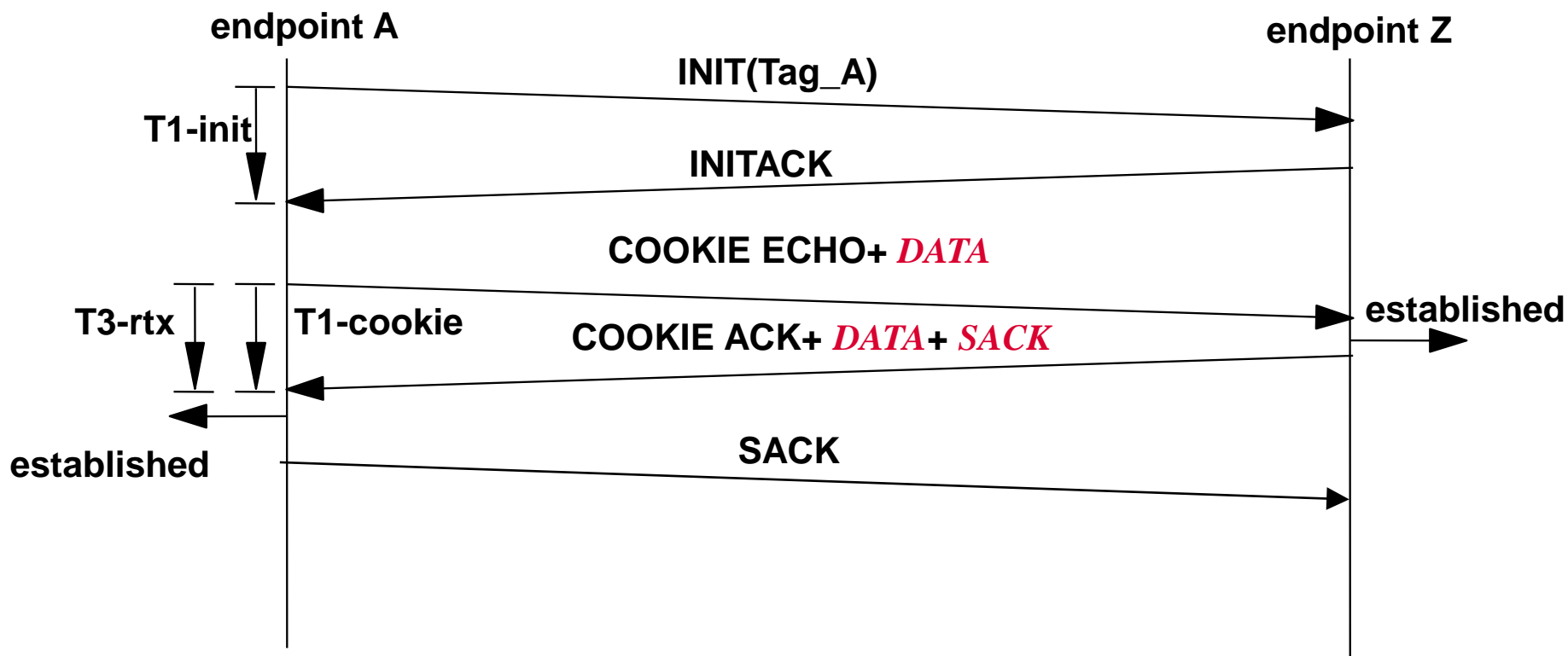

Avoid attack of **DOS** and **IP address** cheating

SCTP Delivery in Streams

- ➔ **Example:** There are two streams in the association from A to B. And there are 4 data package: A,B,C,D to send. The arrangement is like this: A on stream 1, B on stream 2, C on stream 1, D on stream 2. D is quite big so it's divided to D1 and D2.

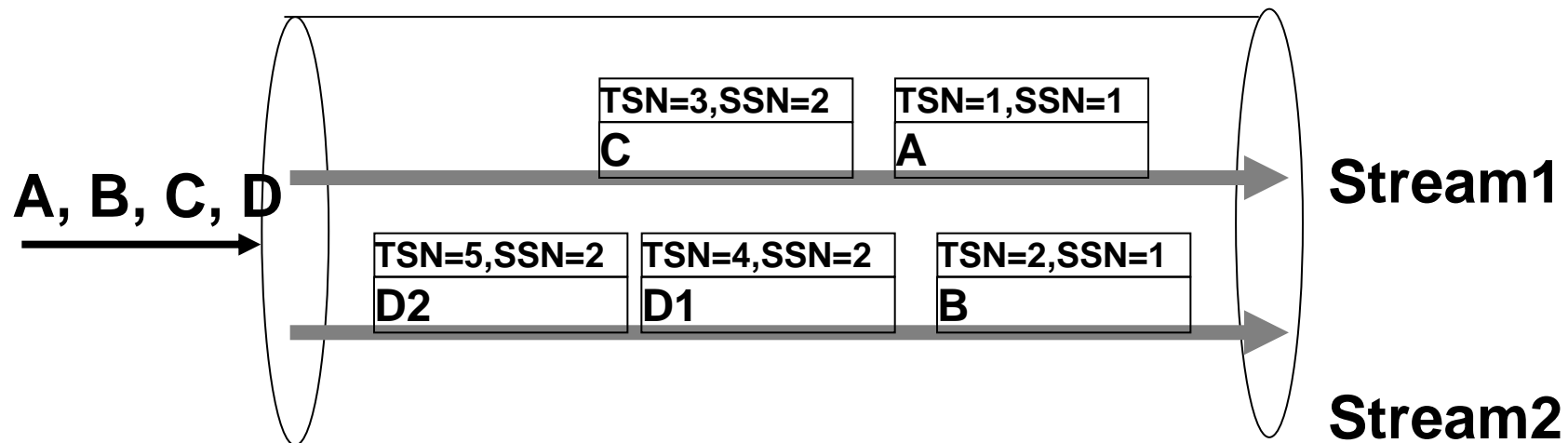

SCTP Delivery in Streams

➔ TSN (Transmission Sequence Number)

- A 32-bit sequence number assigned by an endpoint, which is based on an initial TSN, to each data chunk sent by the local end to permit the receiving SCTP endpoint to acknowledge its receipt.
- TSN is maintained on the basis of association.

➔ SSN (Stream Sequence Number)

- A 16-bit stream sequence number assigned by SCTP to each data chunk sent in a stream by the local end, to ensure sequenced transmission in the stream.

➔ The assignments of TSN and SSN are independent to each other.

SCTP Delivery in Streams— Message Structure

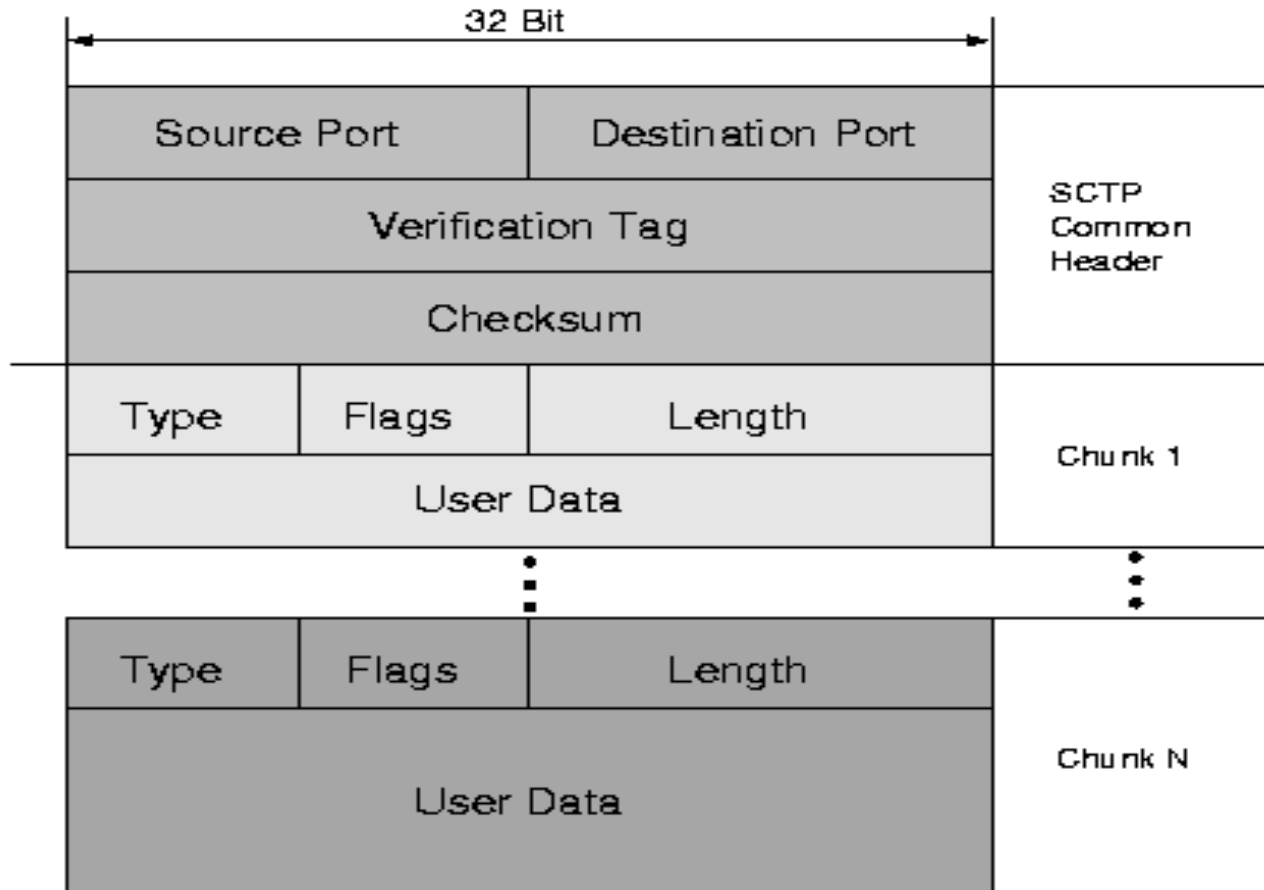

SCTP Delivery in Streams—DATA Message Structure

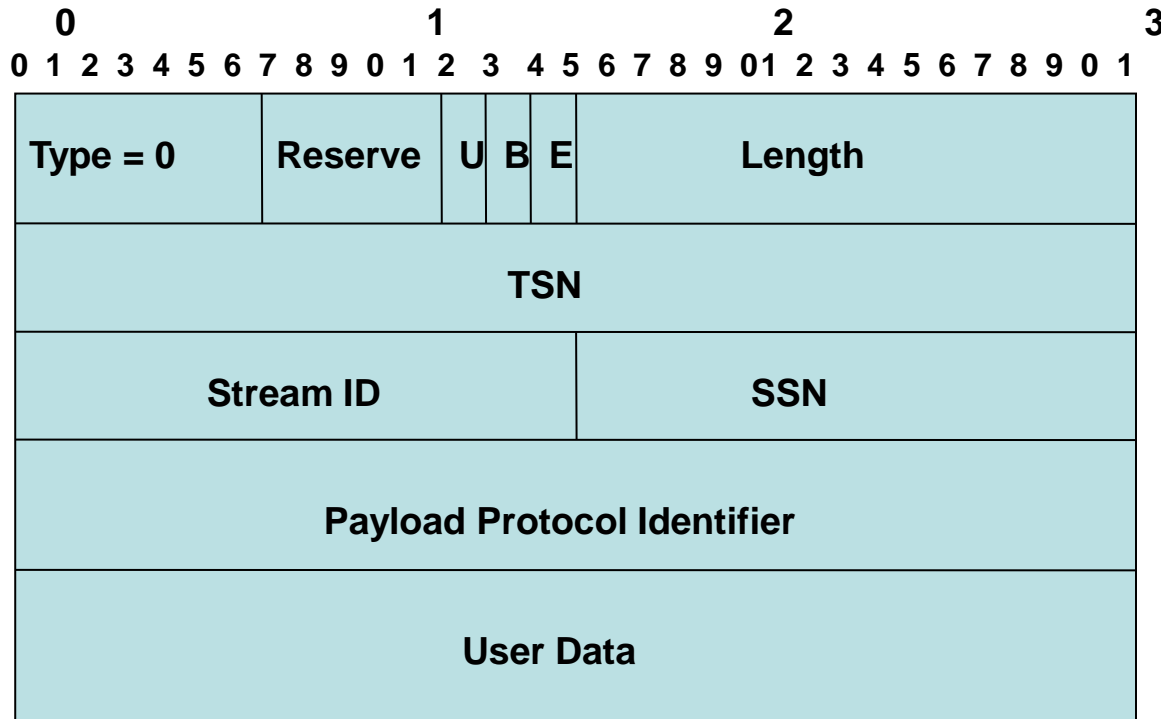

SCTP Delivery in Streams—DATA Message Structure

- ➔ **U bit:** The unordered bit, if set to “1”, indicates that this is an unordered DATA chunk, and there is no stream sequence number assigned to this DATA chunk.
- ➔ **B bit:** The beginning fragment bit.
- ➔ **E bit:** The ending fragment bit.

B	E	Meaning
1	0	First piece of a fragmented user message
0	0	Middle piece of a fragmented user message
0	1	Last piece of a fragmented user message
1	1	Unfragmented message

- ➔ **Length:** from the beginning of the type field to the end of the user data field
- ➔ **TSN:** 0~4294967295
- ➔ **Stream Identifier**
- ➔ **Stream sequence number:** 0 to 65535

SCTP Acknowledgement

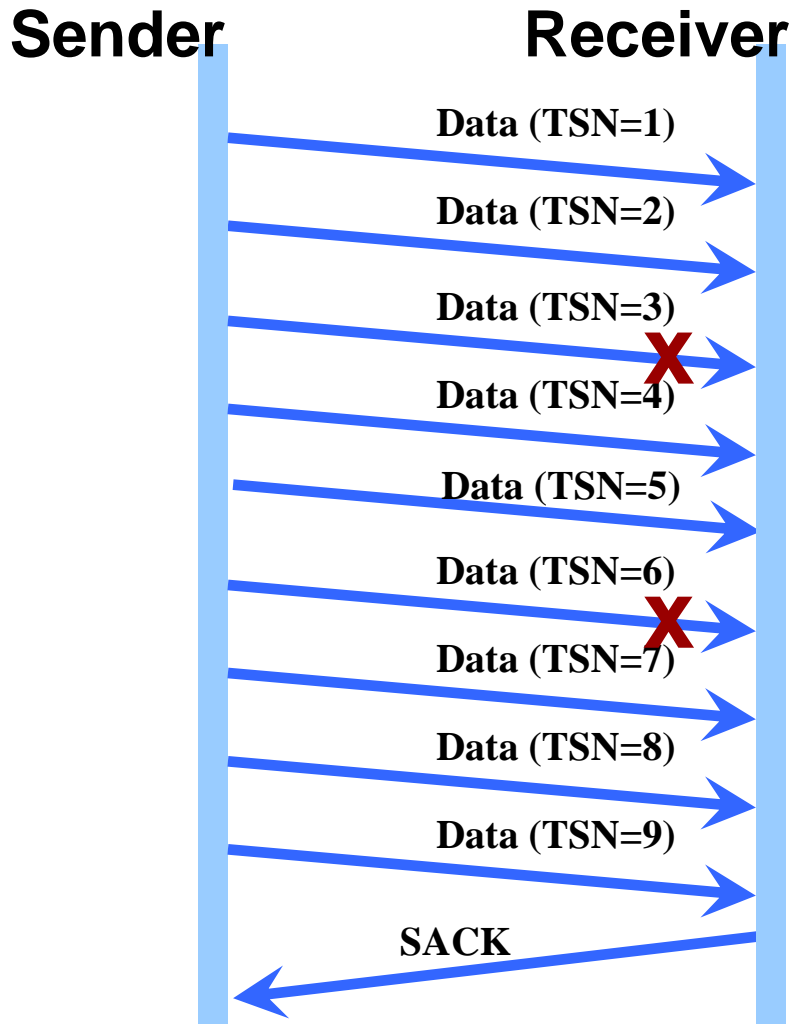

- ➔ Cumulative TSN Ack: 2
- ➔ Number of Gap Ack Blocks: 2
 - Gap 1: start=4, end=5
 - Gap 2: start=7, end=9
- ➔ When sender received 4 such SACK continually, resend will start.
- ➔ Usually, receiver will send a SACK every two data package or after 200ms on receiving.

SCTP Acknowledgement — SACK Message Structure

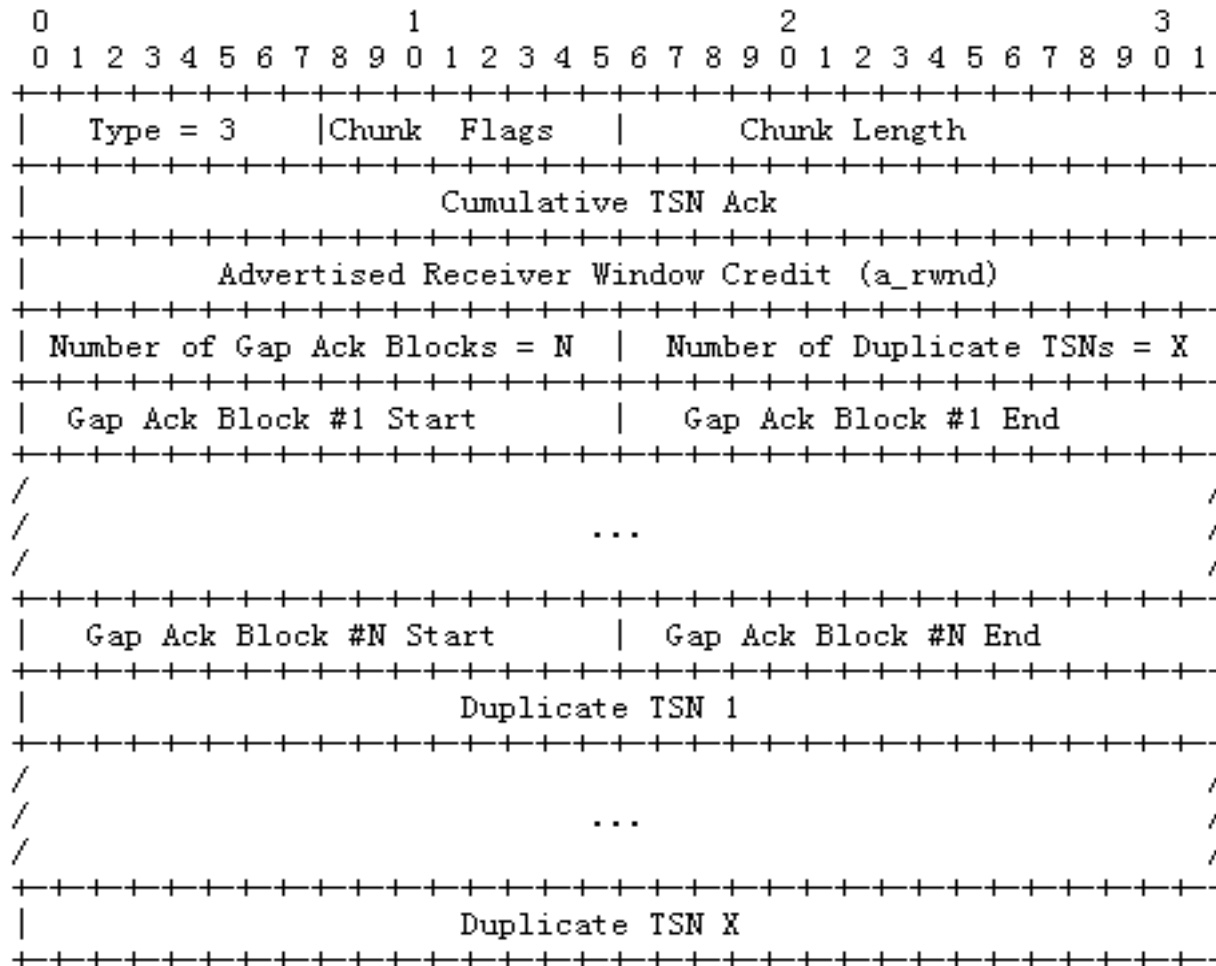

SCTP Delivery Mechanism

- ➔ **Sliding window:**
 - Receiver window (RWND)
 - Congestion window (CWND)
- ➔ **Cumulative and selective acknowledgement**
- ➔ **Packet retransmission**
- ➔ **Multi-homing function**
- ➔ **Actually, except multi-homing function and selective acknowledgement, SCTP has similar features as TCP.**

SCTP Delivery — Real-time Feature

- ➔ **Package-based feature.** Normally message will be delivered immediately without being bundled. The bundle usually used in retransmission case.
- ➔ **SCTP can deliver message in sequence or with no sequence.** In no sequence case, the receiver can report the data to upper layer immediately after receiving.
- ➔ **SCTP's sequence delivery is acted in the stream.** If disorder happened in one stream, the stream will wait till all packages in order before reporting to next section. And this won't effect other stream.
- ➔ **So SCTP ensures the real-time feature on sender and receiver.**

SCTP Delivery — Sliding Windows

- ➔ **Receiver window (RWND):** indicates the size of the receiver's inbound buffer in an association.
 - The two RWND values will vary with data transmission and acknowledgement.
 - If the RWND is equal to 0, the data sender can always have one packet in flight to the receiver.
 - Before sending packages, SCTP will check the number of unacknowledged package to sure it's smaller than RWND.
 - The retransmission data has higher priority than new data.
- ➔ **Congestion window (CWND):**
 - maintained on the basis of each destination address and will be adjusted according to the network condition.
 - Once the length of the unacknowledged message sent from the destination address is greater than the CWND value, the endpoint will stop transmitting data to this address.
- ➔ **RWND and CWND are maintained on different object.**

SCTP Delivery — Retransmission

- ➔ **SCTP starts a T3 timer for each destination address (or each package).**
 - **After receiving SACK, if all data are acknowledged, T3 will be stopped. If only partial acknowledged, then SCTP will restart T3 timer.**
 - **If T3 timeout, SCTP will check the PMTU, then bundle all unacknowledged data into one package, send it to destination address and start T3.**

SCTP Delivery — Multi-homing

- ➔ **An SCTP association might include several paths but has only one primary path.**
 - **CWND, T3 timer are based on transmission address**
 - **An endpoint should always transmit SCTP packets through the primary path from a local transport address A to the peer endpoint.**
 - **The acknowledgement will always choose the original source address as the destination address first.**
 - **Retransmission may choose a different address if possible.**

SCTP Congestion Avoidance

- ➔ **SCTP congestion controlling is similar with TCP:**
 - **Slow start-up**
 - **Congestion avoidance**
 - **Congestion control**
 - **Fast retransmission**

- ➔ **Actually, except fast retransmission, the other three methods are describing CWND.**

SCTP Path Management

➔ Managing the state of the SCTP association (endpoint)

- There is a counter for each endpoint. The counter records the number of retransmission. If there are multi-address, then all the retransmission times are included. If the counter exceeds “Association.Max.Retrans”, then the endpoint will be regarded as unreachable and SCTP will enter “CLOSED” state with a report to upper layer. The counter will be reset when one data is acknowledged by the receiver.

➔ Managing the state of the path

- A counter for each transmission address records the T3-expiring-number and the number of heartbeat without response. If the counter exceeds “Path.Max.Retrans”, then this address will be regarded as unreachable. If the acknowledgement of data or heartbeat are received on this address, then the counter will be reset.

SCTP Path Management

➔ **Hearbeat**

- **When a path is idle, the local SCTP user requires the SCTP to generate a heartbeat message and sends the message through that path to the peer endpoint which must immediately return a heartbeat acknowledgement message.**
- **This mechanism serves to precisely measure the round-trip time (RTT) and helps to monitor the reachability of the association as well as holding the active state of the SCTP association.**
- **The interval of heartbeat can be configured.**

Objectives

- ➔ Data Communication Overview
- ➔ TCP/IP Model
- ➔ Physical Layer
- ➔ DataLink Layer
- ➔ Network Layer
- ➔ Transport Layer
- ➔ **Application Layer**

Application Layer Overview

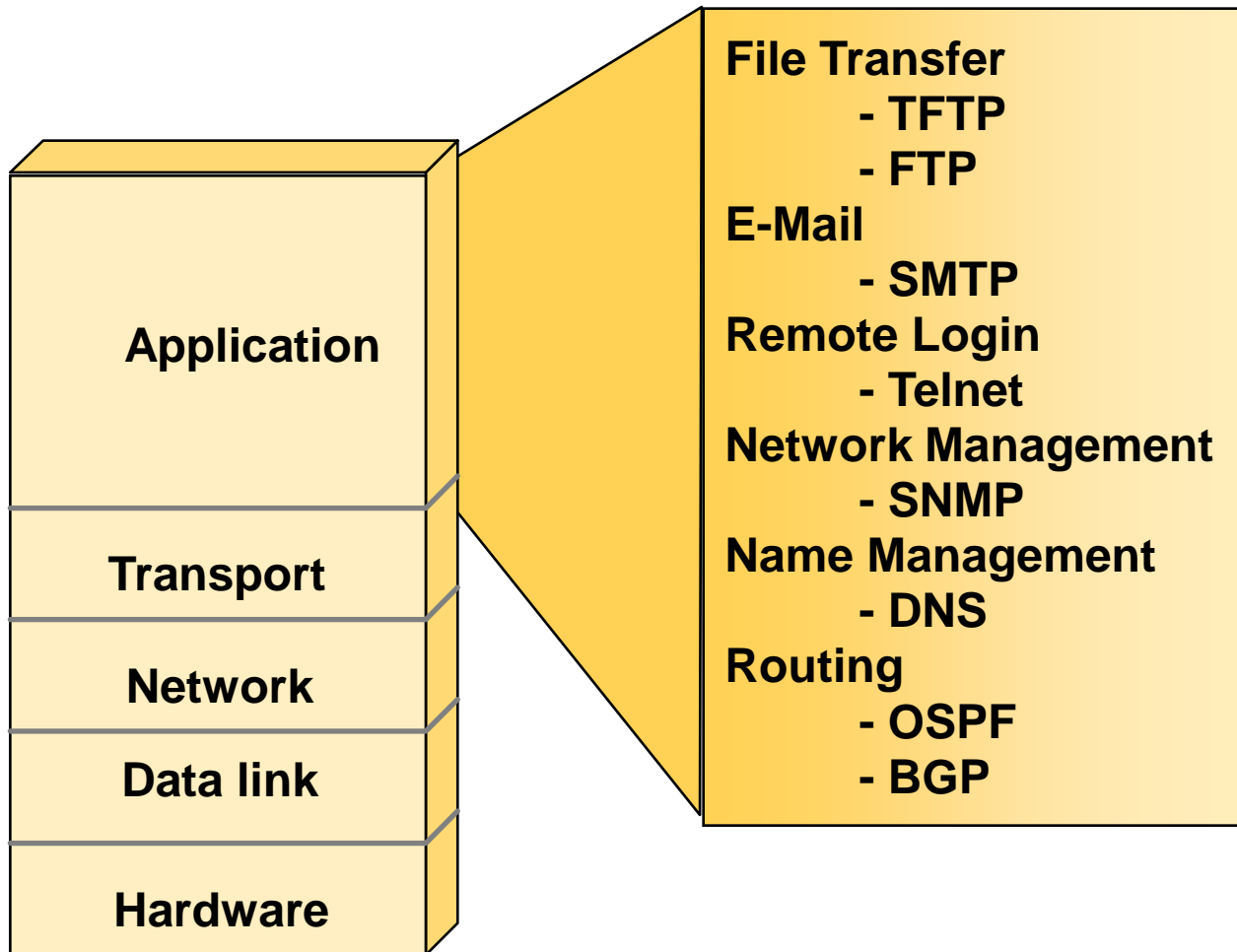

Thank you

www.huawei.com